



Safety Relay Modules

HR6S



Safety Relay Modules

Improve productivity with predictive maintenance of safety systems

IDEC CORPORATION

Safety Relay Modules for IoT

The basis of a functional safety system is to use diagnosis to detect failures.

Redundant control systems, for example, maintain safety by detecting the occurrence of a single failure, and at the same time give user the opportunity to replace parts. This concept, which was introduced through international standards in 1999, has adopted throughout the world the idea of safety by control based on safety relay modules.

With the recent progress of IT technology, IoT is being promoted at factories around the world for the purpose of optimizing productivity. The optimal allocation of resources and predictive maintenance are important in such factories. However, predictive maintenance for safety systems that directly influence machine operation is especially important, and is indispensable for achieving both productivity and safety.

The HR6S safety relay module has advanced diagnostic functions, and can output the results. The diagnostic function, which is backed by international standards, monitors the safety relay module and the devices that are connected to it, and contributes to predictive maintenance for the safety system.



Advanced Diagnostic and Output Functions

Predictive Maintenance

Not only diagnostic results, but detailed information regarding safety-related parts such as input/output status can be acquired to prevent unintended stops. (For details, see page 30.)

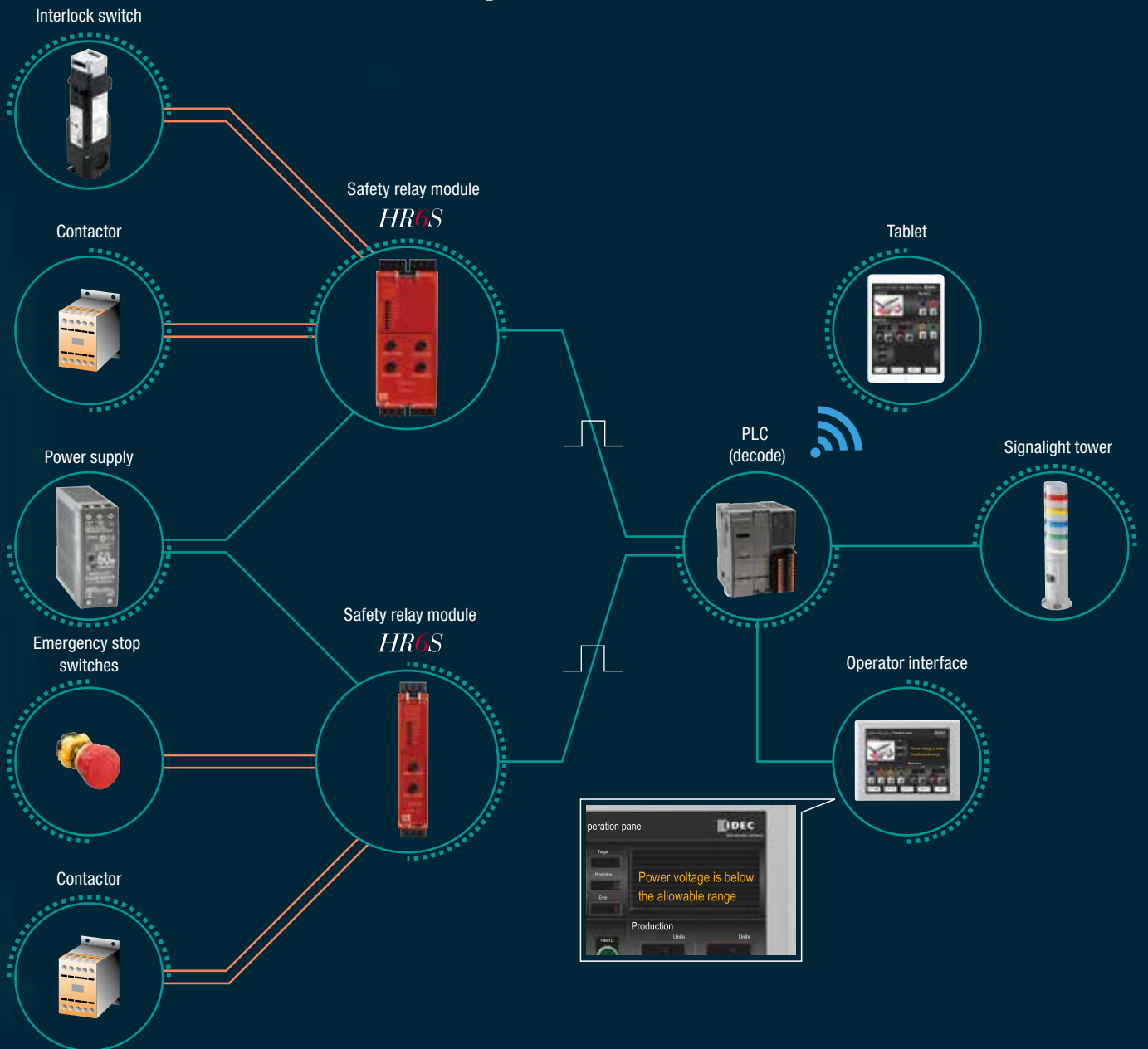

HR6S

SAFETY RELAY MODULE



Connect to Various Input Devices

Dials are used to select input devices and start functions to enable safety measures for a wide variety of machines and allows standardization of the relay module.



Setting a start function

Select from 8 types of start functions without changing the wiring. Automatic and manual operation can be selected as well as "startup test", which requires monitoring, cross-circuit detection, and pre-start inspection.

(For details, see page 31.)

Setting an application function

Set up to 7 types of input devices, such as emergency stop switches, interlock switches, light curtains, RFID devices, magnet switches, proximity switches, two-hand control switches, and pressure-sensitive switches.





Protection

A sealing strip to secure the protective cover is included, preventing the dials from inadvertent adjustment or settings from being changed.



P R O T E C T I V E C O V E R

Output Expansion

Outputs can be expanded (excluding HR6S-AB). No wiring is required, because expansions are connected via the connector on the side of the unit.



O U T P U T E X P A N S I O N

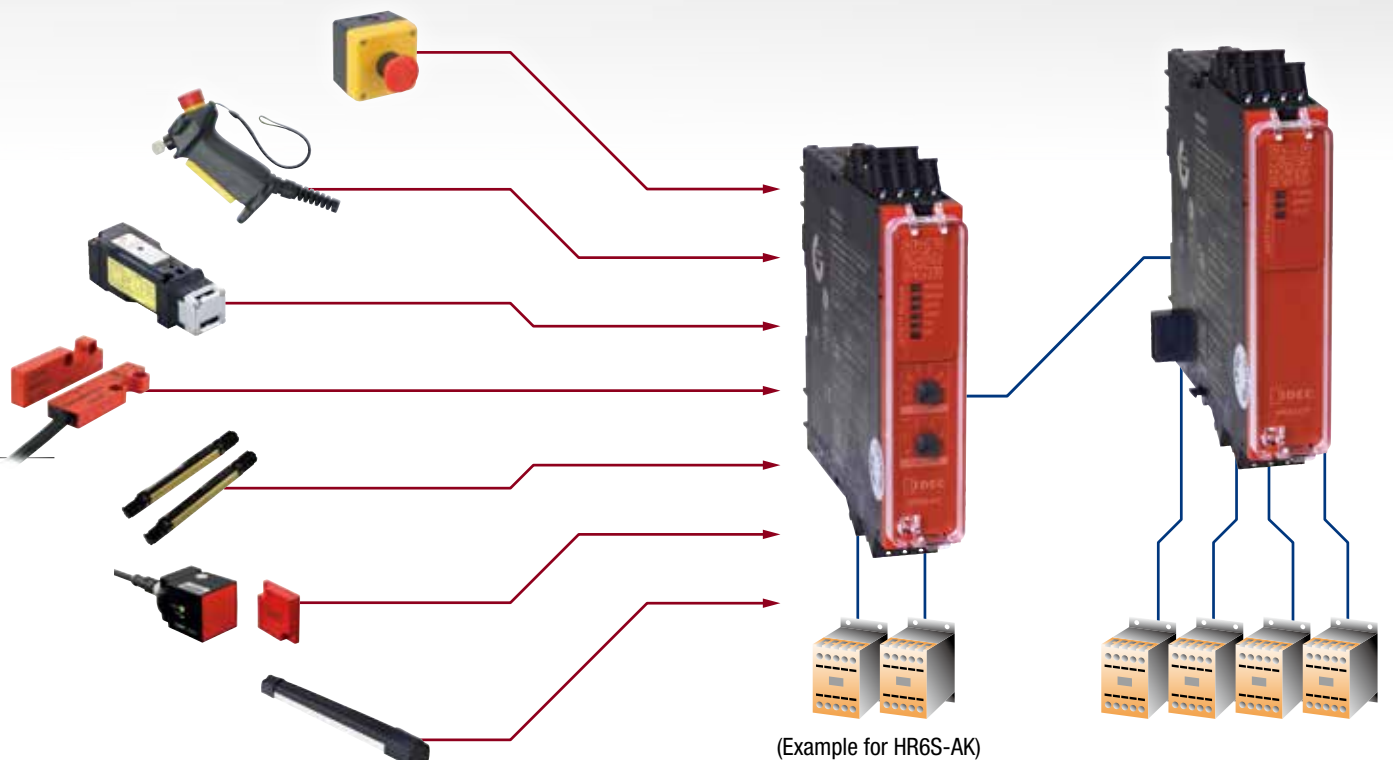

(Example for HR6S-AK)

LED Display for Viewing Status at a Glance

The LED indicators display approximately 20 different states by steady or flash light, or by combining. (For details, see page 28.)
When an error occurs, its location is indicated, allowing maintenance to be performed immediately.

ERROR does not light on.



Indicates that safety-related input is activated.

ERROR flashes, and S12 and S22 flash alternately.

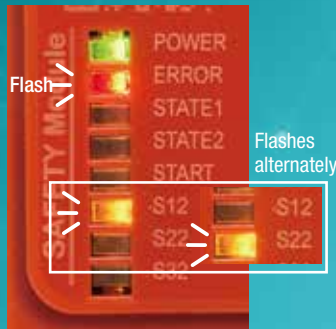

Indicates a safety input synchronization alert.

ERROR is steady, and either S12 or S22 flashes. If both flash, the flashing synchronizes.

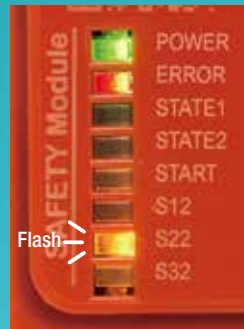

Indicates a cross circuit in a safety input.

All LEDs light on.



Indicates that an inappropriate function mode has been set, or a setting has been changed after power on.

Delay Function

By using the dials to set a combination of a coefficient from 0 to 0.9 and a magnification from 1x to 1000x, time limit can be set in the range of 0 to 900 seconds.

Also, the external input can be used to cancel the off-delay and immediately cut off the output. Expanded (*1) output can be set to either instantaneous or delay.



*1: Expansion output is set to instantaneous for 1 to 4, and to delay output for 5 to 8.

Screw or Push-in Terminal Block

Choose from two types: a conventional screw terminal block or a highly-reliable push-in terminal block that saves wiring time. Both are removable and easy to maintain.



Push-in terminal



Screw terminal

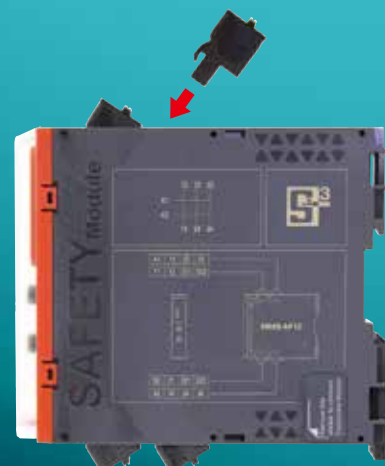

		Safety Relay Module							Expansion Module	Category 2 Safety Relay Module		
		 HR6S-AB (page 8)	 NEW HR6S-BAC (page 25)	 HR6S-AF (page 10)	 HR6S-AK (page 12)	 HR6S-AT (page 14)	 HR6S-S (page 17)	 HR6S-DN (page 20)	 HR6S-EP (page 23)	 HR5S-C2S	 HR5S-C2B	 HR5S-C2D
Maximum PL (*1)		c	e	e	e	e	e	e	c	d	d	
Safety category (*1)		1	3	3, 4	3, 4	3, 4	3, 4	3, 4	2	2	2	
Delay (sec)						0, 0.1, 0.2, 0.3 ... 900			0, 0.1, 0.2, 0.3 ... 900		0.25 to 4 (*5)	
Input devices that can be connected (*2)	 Emergency stop switch	√√	√√	√√	√	√√	√	√	√	√	√	
	 Electrical switch	√√	√√	√√	√	√√	√	√	√	√	√	
	 Coded magnetic switch (magnetic type)	√√		√√	√	√√	√	√		√	√	
	 Proximity sensor	√√		√√	√	√√	√	√				
	 RFID sensor	√√		√√	√	√√	√	√				
	 ESPE	√√		√√	√	√√	√	√				
	 Pressure-sensitive switch				√√	√√						
	 Two-hand control switch	√√ IIIA					√√ IIIA, IIIC					
Parallel input for input device		1 system	1 system	1 system	1 system	1 system	2 systems	6 systems	1 system	1 system	1 system	
Safety-related output	Instantaneous	1C (SPDT)	4NO1NC	3NO	2NO-1NC	3NO	2NO	3NO-1NC	4NO-2NC (*3)	2NO	2NO	(*4)
	Delay					3NO-1NC						1NO
Output expansion 				√	√	√	√	√				
Status output (Semiconductor)	All diagnostic results (For details, see page 31.)	√		√	√	√	√	√				
	Safety-related output monitor					√						
	Failure detection output								√	√	√	
Number of LEDs		6	5	6	6	8	8	16	3	2	2	3

• First, determine the PLr and category of the safety system.

*1: NC contacts are compatible with category 1 and PLC.

*2: Although both "√" and "√√" can be connected, models indicated with "√√" is recommended for use. When inputting multiple input devices in parallel, select either HR6S-S or HR6S-DN.

*3: When connecting to HR6S-AT, use the selector to select instantaneous or delay.

*4: Non-safety-related instantaneous output available.

*5: 5 types - 0.25 s, 0.5 s, 1 s, 2 s, and 4 s.

Performance level of facilities and applicable models

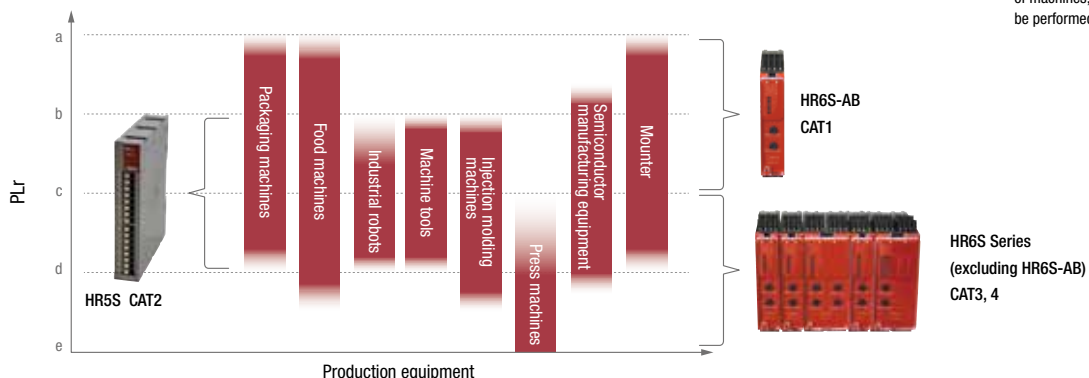

• When defining the performance level of machines, a risk assessment must be performed for each machine.

HR6S-AB Safety Relay Module

PLc achieved with Category 1 configuration

- With a variety of common input devices, the HR6S-AB can monitor two-hand control devices (IIIA) that are required to comply with ISO 13851.
- Suitable for use as a self-holding circuit for selecting a wide variety of start functions for low-risk machines.
- Output cannot be expanded using expansion modules.



HR6S-AB

Package Quantity: 1

Terminal	Part No.	Supply Voltage
Push-in terminal	HR6S-AB1C	24V AC/DC
Screw terminal	HR6S-AB1P	24V AC/DC

- One sealing strip (see page 28) is included with each product.



• See website for details on approvals and standards.

Overview of Application Functions

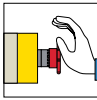

Monitoring of Emergency Stop circuits as per ISO 13850 and IEC 60204-1, stop category 0

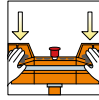

Monitoring of two-hand control devices, type III A as per ISO 13851

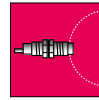

Monitoring of proximity switches

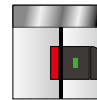

Monitoring of RFID sensors



Monitoring of guards as per ISO 14119/14120 with interlock switches



Monitoring of guards as per ISO 14119/14120 with coded magnetic switches



Monitoring of electro-sensitive protective equipment such as type 4 light curtains as per IEC 61496-1

Safety-Related Outputs

Number of relay contacts, changeover (Normally Closed to Normally Open), instantaneous	1
Maximum short circuit current I _K	1 kA
Maximum continuous current, Normally Open relay contacts	3 A
Maximum continuous current, Normally Closed relay contacts	3 A
Maximum total thermal current ΣI_{THERM}	3 A
Minimum current	10 mA
Utilization category as per UL 60947-5-1	D300 and R300
Utilization category as per IEC 60947-4-1 and IEC 60947-5-1	AC-1: 250 V AC-15: 250 V DC-1: 24 V DC-13: 24 V
Maximum current, normally open relay contacts	AC-1: 5 A AC-15: 3 A DC-1: 5 A DC-13: 2 A
Maximum current, normally closed relay contacts	AC-1: 3 A AC-15: 1 A DC-1: 3 A DC-13: 1 A
External fusing	6 A, category gG

Additional Non-Safety-Related Outputs

Output voltage	24V DC
Maximum current	20 mA

Synchronization Times

The synchronization times for the synchronization of safety-related inputs depend on the application function. (See page 9 Function Mode Selector and Input Device Connection Example.)

Data Functional Safety

Defined safe state	Safety-related outputs are de-energized Normally Open: open Normally Closed: closed	
Maximum Performance Level (PL), Category (as per ISO 13849-1:2015)	PLc, Category 1	
Maximum Safety Integrity Level (SIL) (as per IEC 61508-1:2010)	1	
Safety Integrity Level Claim Limit (SILCL) (as per IEC 62061:2005+AMD1:2012+AMD2:2015)	1	
Type (as per IEC 61508-2)	B	
Hardware Fault Tolerance (HFT) (as per IEC 61508 and IEC 62061)	0	
Stop Category for Emergency Stops (as per ISO 13850 and IEC 60204-1)	0	
Lifetime in years at an ambient temperature of 55 °C (131 °F)	20	
Safe Failure Fraction (SFF) (as per IEC 61508 and IEC 62061)	>60 %	
Probability of Dangerous Failure per hour (PFH _D) in 1/h (as per IEC 61508 and ISO 13849-1)	1175.6 x 10 ⁻⁹	
Mean Time To Dangerous Failure (MTTF _D) in years (as per ISO 13849-1)	91 (*1)	
Average Diagnostic Coverage (DC _{avg}) (none as per ISO 13849-1)	—	
Maximum number of cycles over lifetime	DC-13	24V DC 2 A: 50000
	AC-15	250V AC 3 A: 50000

*1) According to ISO 13849-1 Annex K

For other specifications (common to all models), see page 27.

HR6S-AB

Wiring

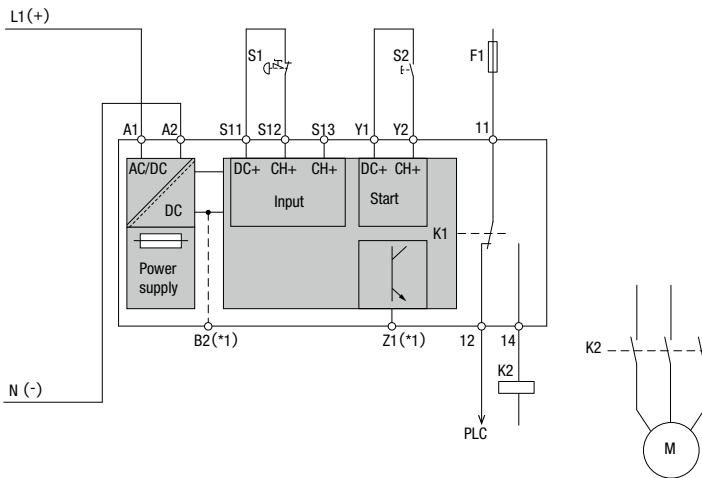

Designation	Explanation
B2	Common reference potential terminal
Z1	Pulsed output for diagnostics, not safety-related
S1	Emergency stop switch
S2	Start switch
K2	Contacter
M	Motor
F1	Fuse

*1) For B2 and Z1, see HR6S-AF.

Function Mode Selector and Input Device Connection Example

Dial 1	Dial 2	Dial 3	Dial 4	Dial 5	Dial 6
<p>Synchronous monitoring: No Dynamization: Yes Signal interlock monitoring: No</p> <p>Emergency stop switches</p> <p>Interlock switch</p>	<p>Synchronous monitoring: 0.5 s Dynamization: Yes Signal interlock monitoring: No</p> <p>Two-hand control switch (IIA)</p>	<p>Synchronous monitoring: 0.5 s Dynamization: Yes Signal interlock monitoring: No</p> <p>Coded magnetic switch (*2) (1NO, 1NC)</p>	<p>Synchronous monitoring: 2.2 s Dynamization: Yes Signal interlock monitoring: No</p>	<p>Synchronous monitoring: No Dynamization: No Signal interlock monitoring: No</p> <p>1 PNP output device</p>	<p>Synchronous monitoring: 0.5 s Dynamization: No Signal interlock monitoring: Yes</p> <p>2 OSSD Output device</p>

*2: Connection examples for coded magnetic switches such as HS7A (IDEC) are also included on the instruction sheet, but certifications are not available.
Note: Status of contacts in the diagram: The status of the control switch is when it is not operated. The status of the door interlock is when the door is closed.

HR6S-AF Safety Relay Module

Standard module for building safety systems

- Protects both the operator and the machine by immediately stopping dangerous movements when instructed to stop by the operator or when a failure in the safety circuit is detected.
- The most basic module for building a safety system.



• See website for details on approvals and standards.

HR6S-AF

Package Quantity: 1

Terminal	Part No.	Supply Voltage
Push-in terminal	HR6S-AF1C	24V AC/DC
Screw terminal	HR6S-AF1P	24V AC/DC

- One sealing strip (see page 28) is included with each product.



Output expansion possible

Overview of Application Functions

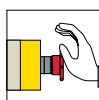

Monitoring of Emergency Stop circuits as per ISO 13850 and IEC 60204-1, stop category 0



Monitoring of guards as per ISO 14119/14120 with coded magnetic switches

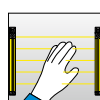

Monitoring of electro-sensitive protective equipment such as type 4 light curtains as per IEC 61496-1



Monitoring of guards as per ISO 14119/14120 with interlock switches

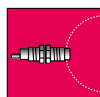

Monitoring of proximity switches

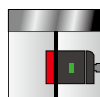

Monitoring of RFID sensors

Safety-Related Outputs

Number of relay contacts, Normally Open, instantaneous	3
Maximum short circuit current IK	1 kA
Maximum continuous current, Normally Open relay contacts	6 A
Maximum total thermal current ΣI_{THERM}	12 A
Minimum current	10 mA
Utilization category as per UL 60947-5-1	B300 and R300
Utilization category as per IEC 60947-4-1 and IEC 60947-5-1	AC-1: 250 V AC-15: 250 V DC-1: 24 V DC-13: 24 V
Maximum current, normally open relay contacts	AC-1: 5 A AC-15: 3 A DC-1: 5 A DC-13: 3 A
External fusing	10 A, category gG

Additional Non-Safety-Related Outputs

Output voltage	24V DC
Maximum current	20 mA

Synchronization Times

The synchronization times for the synchronization of safety-related inputs depend on the application function. (See page 11 Function Mode Selector and Input Device Connection Example.)

Data Functional Safety

Defined safe state	Safety-related outputs are de-energized open	
Maximum Performance Level (PL), Category (as per ISO 13849-1:2015)	PL e, Category 4	
Maximum Safety Integrity Level (SIL) (as per IEC 61508-1:2010)	Normally Open: 3	
Safety Integrity Level Claim Limit (SILCL) (as per IEC 62061:2005+AMD1:2012 +AMD2:2015)	Normally Open: 3	
Type (as per IEC 61508-2)	B	
Hardware Fault Tolerance (HFT) (as per IEC 61508 and IEC 62061)	1	
Stop Category for Emergency Stops (as per ISO 13850 and IEC 60204-1)	0	
Lifetime in years at an ambient temperature of 55 °C (131 °F)	20	
Safe Failure Fraction (SFF) (as per IEC 61508 and IEC 62061)	<99 %	
Probability of Dangerous Failure per hour (PFH _D) in 1/h (as per IEC 61508 and ISO 13849-1)	1.13 x 10 ⁻⁹	
Mean Time To Dangerous Failure (MTTF _D) in years (as per ISO 13849-1)	2,000 (*1)	
Average Diagnostic Coverage (DC _{avg}) (as per ISO 13849-1)	≥99 %	
Maximum number of cycles over lifetime	DC-13	24V DC 1 A: 1,200,000 24V DC 3 A: 180,000
	AC-1	250V AC 4 A: 180,000
	AC-15	250V AC 1 A: 70,000
		250V AC 5 A: 39,000

*1) According to ISO 13849-1 Annex K

For other specifications (common to all models), see page 27.

HR6S-AF

Wiring

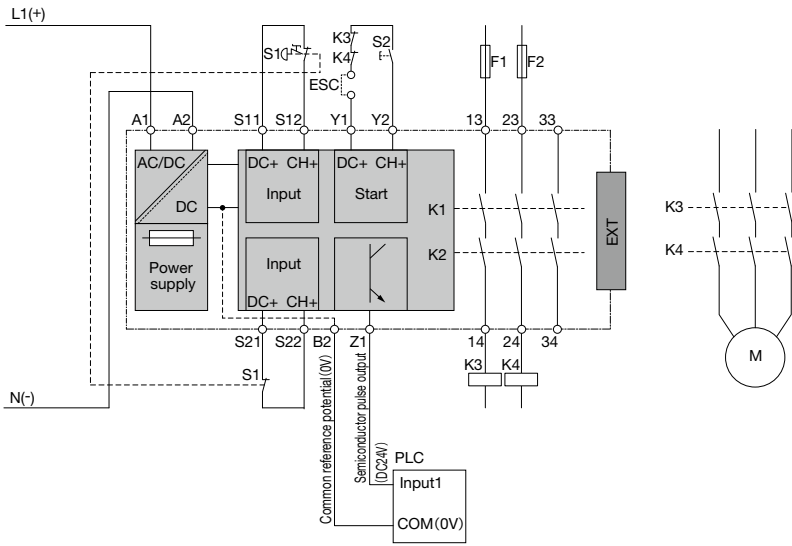

Designation	Explanation
EXT	Connector for optional expansion module
S1	Emergency stop switch
S2	Start switch
K3, K4	Contactor
M	Motor
PLC	Programmable controller
F1, F2	Fuse

Function Mode Selector and Input Device Connection Example

Dial 1	Dial 2	Dial 3
<p>Synchronous monitoring: No Dynamization: Yes Signal interlock monitoring: Yes</p>	<p>Synchronous monitoring: 2 s / 4 s (S12 first / S22 first) Dynamization: Yes Signal interlock monitoring: Yes</p>	<p>Synchronous monitoring: 0.5 s Dynamization: Yes Signal interlock monitoring: No</p>
Emergency stop switches	Electrical switch	Interlock switch (1 NO, 1 NC) Coded magnetic switch (1 NO, 1 NC) (*1) Proximity switch (1 NO, 1 NC)
Dial 4	Dial 5	Dial 6
<p>Synchronous monitoring: No Dynamization: No Signal interlock monitoring: Yes</p>	<p>Synchronous monitoring: 0.5 s Dynamization: No Signal interlock monitoring: Yes</p>	<p>Synchronous monitoring: 0.5 s Dynamization: No Signal interlock monitoring: Yes</p>
1 PNP × 2	2 OSSD	ESPE

*1: Connection examples for coded magnetic switches such as HS7A (IDEC) are also included on the instruction sheet, but certifications are not available.
Note: Status of contacts in the diagram: The status of the control switch is when it is not operated. The status of the door interlock is when the door is closed.

HR6S-AK Safety Relay Module

Connects to pressure-sensitive switches such as mat switches

- Protects both the operator and the machine by immediately stopping dangerous movements when instructed to stop by the operator or when a failure in the safety circuit is detected.
- Connects to pressure-sensitive switches such as mat switches or edge switches.
- NC contact is available for output.



Output expansion possible



• See website for details on approvals and standards.

HR6S-AK

Package Quantity: 1

Terminal	Part No.	Supply Voltage
Push-in terminal	HR6S-AK1C	24V AC/DC
Screw terminal	HR6S-AK1P	24V AC/DC

- One sealing strip (see page 28) is included with each product.

Overview of Application Functions



Monitoring of Emergency Stop circuits as per ISO 13850 and IEC 60204-1, stop category 0



Monitoring of guards as per ISO 14119/14120 with coded magnetic switches



Monitoring of electro-sensitive protective equipment such as type 4 light curtains as per IEC 61496-1



Monitoring of pressure-sensitive 4-wire protective devices such as mats or edges as per ISO 13856

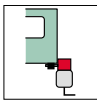

Monitoring of guards as per ISO 14119/14120 with interlock switches

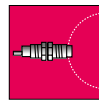

Monitoring of proximity switches

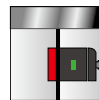

Monitoring of RFID sensors

Safety-Related Outputs

Number of relay contacts, Normally Open, instantaneous	2
Number of relay contacts, Normally Closed, instantaneous	1
Maximum short circuit current IK	1 kA
Maximum continuous current, Normally Open relay contacts	6 A
Maximum continuous current, Normally Closed relay contacts	3 A
Maximum total thermal current ΣI_{THERM}	12 A
Minimum current	10 mA
Utilization category as per UL 60947-5-1	B300 and R300 for Normally Open contacts D300 and R300 for Normally Closed contacts
Utilization category as per IEC 60947-4-1 and IEC 60947-5-1	AC-1: 250 V AC-15: 250 V DC-1: 24 V DC-13: 24 V
Maximum current, normally open relay contacts	AC-1: 5 A AC-15: 3 A DC-1: 5 A DC-13: 3 A
Maximum current, normally closed relay contacts	AC-1: 3 A AC-15: 1 A DC-1: 3 A DC-13: 1 A
External fusing	10 A, category gG, for Normally Open 4 A, category gG, for Normally Closed

Additional Non-Safety-Related Outputs

Output voltage	24V DC
Maximum current	20 mA

Synchronization Times

The synchronization times for the synchronization of safety-related inputs depend on the application function. (See page 13 Function Mode Selector and Input Device Connection Example.)

Data Functional Safety

Defined safe state	Safety-related outputs are de-energized Normally Open: open Normally Closed: closed	
Maximum Performance Level (PL), Category (as per ISO 13849-1:2015)	Normally Open: PL e, Category 4 Normally Closed: PLc, Category 1	
Maximum Safety Integrity Level (SIL) (as per IEC 61508-1:2010)	Normally Open: 3 Normally Closed: 1	
Safety Integrity Level Claim Limit (SILCL) (as per IEC 62061:2005+AMD1:2012+AMD2:2015)	Normally Open: 3 Normally Closed: 1	
Type (as per IEC 61508-2)	B	
Hardware Fault Tolerance (HFT) (as per IEC 61508 and IEC 62061)	1	
Stop Category for Emergency Stops (as per ISO 13850 and IEC 60204-1)	0	
Lifetime in years at an ambient temperature of 55 °C (131 °F)	20	
Safe Failure Fraction (SFF) (as per IEC 61508 and IEC 62061)	>99 %	
Probability of Dangerous Failure per hour (PFH _D) in 1/h (as per IEC 61508 and ISO 13849-1)	1.13 x 10 ⁻⁹	
Mean Time To Dangerous Failure (MTTF _D) in years (as per ISO 13849-1)	2,000 (*1)	
Average Diagnostic Coverage (DC _{avg}) (as per ISO 13849-1)	≥99 %	
Maximum number of cycles over lifetime	DC-13	24V DC 1 A: 1,200,000 24V DC 3 A: 180,000
	AC-1	250V AC 4 A: 180,000
		250V AC 1 A: 70,000
	AC-15	250V AC 5 A: 39,000

*1) According to ISO 13849-1 Annex K

For other specifications (common to all models), see page 27.

HR6S-AK

Wiring

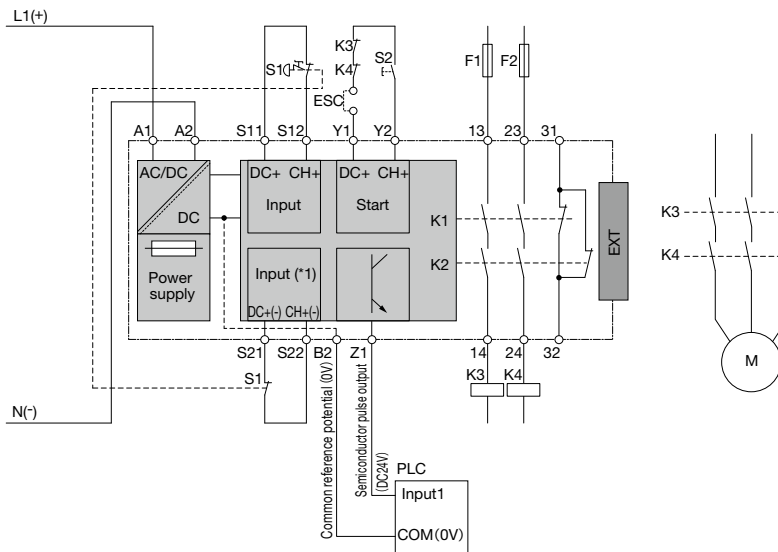

Designation	Explanation
EXT	Connector for optional expansion module
S1	Emergency stop switch
S2	Start switch
K3, K4	Contactors
PLC	Programmable controller
F1, F2	Fuse

*1: The application function sets the negative safe-related input according to the input device.

Function Mode Selector and Input Device Connection Example

Dial 1	Dial 2	Dial 3	
Synchronous monitoring: No Dynamization: Yes Signal interlock monitoring: Yes	Synchronous monitoring: 2 s / 4 s (S12 first / S22 first) Dynamization: Yes Signal interlock monitoring: Yes	Synchronous monitoring: 0.5 s Dynamization: Yes Signal interlock monitoring: No	
Emergency stop switches	Interlock switch	Coded magnetic switch (2 NO) (*2)	
Dial 4	Dial 6	Dial 5	Dial 7
Synchronous monitoring: No Dynamization: No Signal interlock monitoring: Yes	Synchronous monitoring: 0.5 s Dynamization: No Signal interlock monitoring: Yes	Synchronous monitoring: No Dynamization: No Signal interlock monitoring: Yes	Synchronous monitoring: 0.5 s Dynamization: No Signal interlock monitoring: Yes
2 PNP	1 PNP + 1 NPN	Pressure-sensitive switch	OSSD
Dial 8	Dial 9	Dial 10	
Synchronous monitoring: No Dynamization: No Signal interlock monitoring: Yes	Synchronous monitoring: No Dynamization: No Signal interlock monitoring: Yes	Synchronous monitoring: 0.5 s Dynamization: No Signal interlock monitoring: Yes	
Pressure-sensitive switch	OSSD	OSSD	

*2: Connection examples for coded magnetic switches such as HS7A (IDEC) are also included on the instruction sheet, but certifications are not available.

HR6S-AT Safety Relay Module

Equipped with time delay output for Stop Category 0 and Stop Category 1

- Protects both the operator and the machine by immediately stopping dangerous movements (stop category 0) when instructed to stop by the operator or when a failure in the safety circuit is detected. Also, the safety module is equipped with a stop category 1 delay output, which allows the motor to stop after deceleration.
- The selector on the front can be used to set the delay time to a value from 0.1 seconds to 15 minutes. (Can also be set to 0 seconds.)
- The delay output can be canceled by the S21-S22 or S31-S32 terminal (vacant terminal), and the delay output is immediately cut off when canceled.



Output expansion possible

HR6S-AT

Package Quantity: 1

Terminal	Part No.	Supply Voltage
Push-in terminal	HR6S-AT1C	24V AC/DC
Screw terminal	HR6S-AT1P	24V AC/DC

- One sealing strip (see page 28) is included with each product.



- See website for details on approvals and standards.

Overview of Application Functions

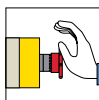

Monitoring of Emergency Stop circuits as per ISO 13850 and IEC 60204-1, stop category 0, 1

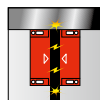

Monitoring of guards as per ISO 14119/14120 with coded magnetic switches

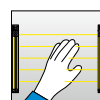

Monitoring of electro-sensitive protective equipment such as type 4 light curtains as per IEC 61496-1

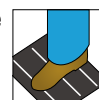

Monitoring of pressure-sensitive 4-wire protective devices such as mats or edges as per ISO 13856



Monitoring of guards as per ISO 14119/14120 with interlock switches

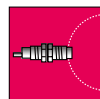

Monitoring of proximity switches

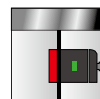

Monitoring of RFID sensors

Safety-Related Outputs

Number of relay contacts, Normally Open, instantaneous	3
Number of relay contacts, Normally Open, delayed	3
Number of relay contacts, Normally Closed, delayed	1
Maximum short circuit current IK	1 kA
Maximum continuous current, Normally Open relay contacts	6 A
Maximum continuous current, Normally Closed relay contacts	3 A
Maximum total thermal current ΣI_{THERM}	12 A
Minimum current	10 mA
Utilization category as per UL 60947-5-1	B300 and R300 for Normally Open contacts D300 and R300 for Normally Closed contacts
Utilization category as per IEC 60947-4-1 and IEC 60947-5-1	AC-1: 250 V AC-15: 250 V DC-1: 24 V DC-13: 24 V
Maximum current, normally open relay contacts	AC-1: 5 A AC-15: 3 A DC-1: 5 A DC-13: 3 A
Maximum current, normally closed relay contacts	AC-1: 3 A AC-15: 1 A DC-1: 3 A DC-13: 1 A
External fusing	10 A, category gG, for Normally Open 4 A, category gG, for Normally Closed

Delay Times for Delay Function of Safety-Related Outputs

Possible values	0 s, 0.1 s, 0.2 s, 0.3 s, 0.4 s, 0.5 s, 0.6 s, 0.7 s, 0.8 s, 0.9 s, 1 s, 2 s, 3 s, 4 s, 5 s, 6 s, 7 s, 8 s, 9 s, 10 s, 20 s, 30 s, 40 s, 50 s, 60 s, 70 s, 80 s, 90 s, 100 s, 200 s, 300 s, 400 s, 500 s, 600 s, 700 s, 800 s, 900 s
-----------------	--

Additional Non-Safety-Related Outputs

Output voltage	24V DC
Maximum current	20 mA











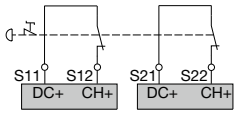

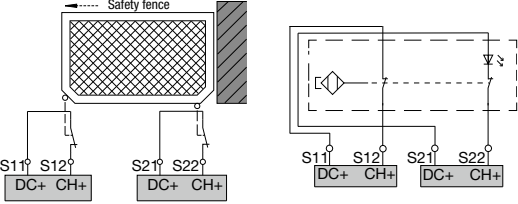

Synchronization Times

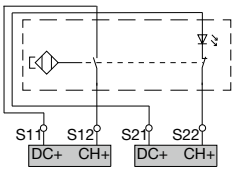
The synchronization times for the synchronization of safety-related inputs depend on the application function. (See page 16 Function Mode Selector and Input Device Connection Example.)

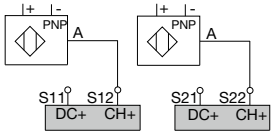
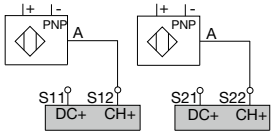
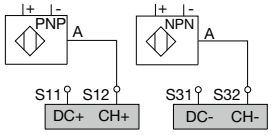
For other specifications (common to all models), see page 27.

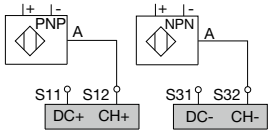
HR6S-AT

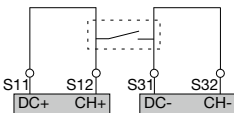
Function Mode Selector and Input Device Connection Example

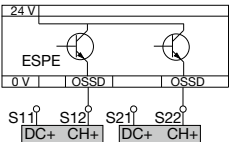
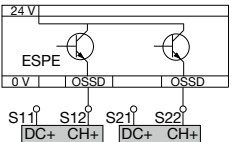
Dial 1	Dial 2	Dial 3	
<p>Synchronous monitoring: No Dynamization: Yes Signal interlock monitoring: Yes</p> <p> Emergency stop switches</p> 	<p>Synchronous monitoring: 2 s / 4 s (S12 first / S22 first) Dynamization: Yes Signal interlock monitoring: Yes</p> <p> Interlock switch</p> <p> Coded magnetic switch (2 NO) (*2)</p> 	<p>Synchronous monitoring: 0.5 s Dynamization: Yes Signal interlock monitoring: No</p> <p> Interlock switch (1 NO, 1 NC)</p> <p> Coded magnetic switch (2 NO, 1 NC) (*1)</p> <p> Proximity switch (1 NO, 1 NC)</p> 	
Dial 4	Dial 6	Dial 5	Dial 7
<p>Synchronous monitoring: No Dynamization: No Signal interlock monitoring: Yes</p> <p> 2 PNP</p> 	<p>Synchronous monitoring: 0.5 s Dynamization: No Signal interlock monitoring: Yes</p> 	<p>Synchronous monitoring: No Dynamization: No Signal interlock monitoring: Yes</p> 	<p>Synchronous monitoring: 0.5 s Dynamization: No Signal interlock monitoring: Yes</p> <p> 1 PNP + 1 NPN</p> 
Dial 8	Dial 9	Dial 10	
<p>Synchronous monitoring: No Dynamization: No Signal interlock monitoring: Yes</p> <p> Pressure-sensitive switch</p> 	<p>Synchronous monitoring: No Dynamization: No Signal interlock monitoring: Yes</p> <p> 2 OSSD</p> 	<p>Synchronous monitoring: 0.5 s Dynamization: No Signal interlock monitoring: Yes</p> 	

*2: Connection examples for coded magnetic switches such as HS7A (IDEC) are also included on the instruction sheet, but certifications are not available. Also, for 2NO, use dial 1 or 2.

Note: Status of contacts in the diagram: The status of the control switch is when it is not operated. The status of the door interlock is when the door is closed.

HR6S-S Safety Relay Module

Monitoring of two hand control devices (IIIA or IIIC)

- Monitors two-hand control devices (IIIA or IIIC) that are required to comply with International Standard ISO 13851.
- IIIC can monitor two-hand pushbuttons for synchronization within 0.5 seconds.
- If one of the two buttons is released during operation, the control sequence is canceled.
- Connects up to two input devices in parallel (except for two-hand control devices (IIIC)). (Outputs are enabled when all inputs are enabled.)



Output expansion possible

HR6S-S

Package Quantity: 1

Terminal	Part No.	Supply Voltage
Push-in terminal	HR6S-S1C	24V AC/DC
Screw terminal	HR6S-S1P	24V AC/DC



• See website for details on approvals and standards.

- One sealing strip (see page 28) is included with each product.

Overview of Application Functions

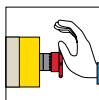

Monitoring of Emergency Stop circuits as per ISO 13850 and IEC 60204-1, stop category 0

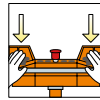

Monitoring of two-hand control devices, type III C as per ISO 13851

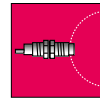

Monitoring of proximity switches

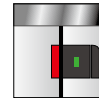

Monitoring of RFID sensors

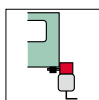

Monitoring of guards as per ISO 14119/14120 with interlock switches



Monitoring of guards as per ISO 14119/14120 with coded magnetic switches

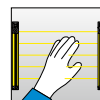

Monitoring of electro-sensitive protective equipment such as type 4 light curtains as per IEC 61496-1

Safety-Related Outputs

Number of relay contacts, Normally Open, instantaneous	2
Maximum short circuit current IK	1 kA
Maximum continuous current, Normally Open relay contacts	6 A
Maximum total thermal current ΣI_{THERM}	12 A
Minimum current	10 mA
Utilization category as per UL 60947-5-1	B300 and R300
Utilization category as per IEC 60947-4-1 and IEC 60947-5-1	AC-1: 250 V AC-15: 250 V DC-1: 24 V DC-13: 24 V
Maximum current, normally open relay contacts	AC-1: 5 A AC-15: 3 A DC-1: 5 A DC-13: 3 A
External fusing	10 A, category gG

Additional Non-Safety-Related Outputs

Output voltage	24V DC
Maximum current	20 mA

Synchronization Times

The synchronization times for the synchronization of safety-related inputs depend on the application function. (See page 18 to 19 Function Mode Selector and Input Device Connection Example.)

For other specifications (common to all models), see page 27.

Data Functional Safety

Defined safe state	Safety-related outputs are de-energized Normally Open: open	
Maximum Performance Level (PL), Category (as per ISO 13849-1:2015)	Normally Open: PLe, Category 4	
Maximum Safety Integrity Level (SIL) (as per IEC 61508-1:2010)	Normally Open: 3	
Safety Integrity Level Claim Limit (SILCL) (as per IEC 62061:2005+AMD1:2012+AMD2:2015)	Normally Open: 3	
Type (as per IEC 61508-2)	B	
Hardware Fault Tolerance (HFT) (as per IEC 61508 and IEC 62061)	1	
Stop Category for Emergency Stops (as per ISO 13850 and IEC 60204-1)	0	
Lifetime in years at an ambient temperature of 55 °C (131 °F)	20	
Safe Failure Fraction (SFF) (as per IEC 61508 and IEC 62061)	>99 %	
Probability of Dangerous Failure per hour (PFH _D) in 1/h (as per IEC 61508 and ISO 13849-1)	1.13 × 10 ⁻⁹	
Mean Time To Dangerous Failure (MTTF _D) in years (as per ISO 13849-1)	2,000 (*1)	
Average Diagnostic Coverage (DC _{avg}) (as per ISO 13849-1)	≥99 %	
Maximum number of cycles over lifetime	DC-13	24V DC 1 A: 1200000 24V DC 3 A: 180000
	AC-1	250V AC 4 A: 180000
	AC-15	250V AC 1 A: 70000
		250V AC 5 A: 39000

*1) According to ISO 13849-1 Annex K

HR6S-S

Wiring Example

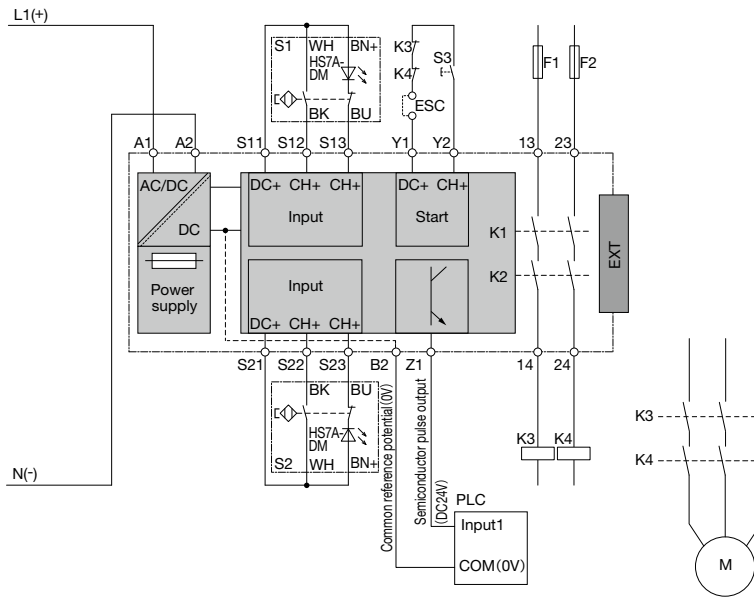

Designation	Explanation
EXT	Connector for optional expansion module
S1, S2	Non-contact interlock switch
S3	Start switch
K3, K4	Contactors
PLC	Programmable controller
F1, F2	Fuse

Function Mode Selector and Input Device Connection Example

Dial 1	Dial 2	Dial 3
<p>Synchronous monitoring: No Dynamization: Yes Signal interlock monitoring: Yes</p> <p>Emergency stop switches</p>	<p>Synchronous monitoring: 2 s / 4 s (S12 first / S22 first) Dynamization: Yes Signal interlock monitoring: Yes</p> <p>Interlock switch</p>	<p>Synchronous monitoring: 0.5 s Dynamization: Yes Signal interlock monitoring: No</p> <p>Two-hand control switch (IIIA)</p>
<p>Dial 4</p> <p>Synchronous monitoring: 0.5 s Dynamization: Yes Signal interlock monitoring: Yes</p> <p>Two-hand control switch (IIIC)</p>	<p>Dial 5</p> <p>Synchronous monitoring: 0.5 s Dynamization: Yes Signal interlock monitoring: No</p> <p>Interlock switch (1 NO, 1 NC)</p> <p>Coded magnetic switch (1 NO, 1 NC) (*1)</p> <p>Proximity switch (1 NO, 1 NC)</p>	

*1: Connection examples for coded magnetic switches such as HS7A (IDEC) are also included on the instruction sheet, but certifications are not available.

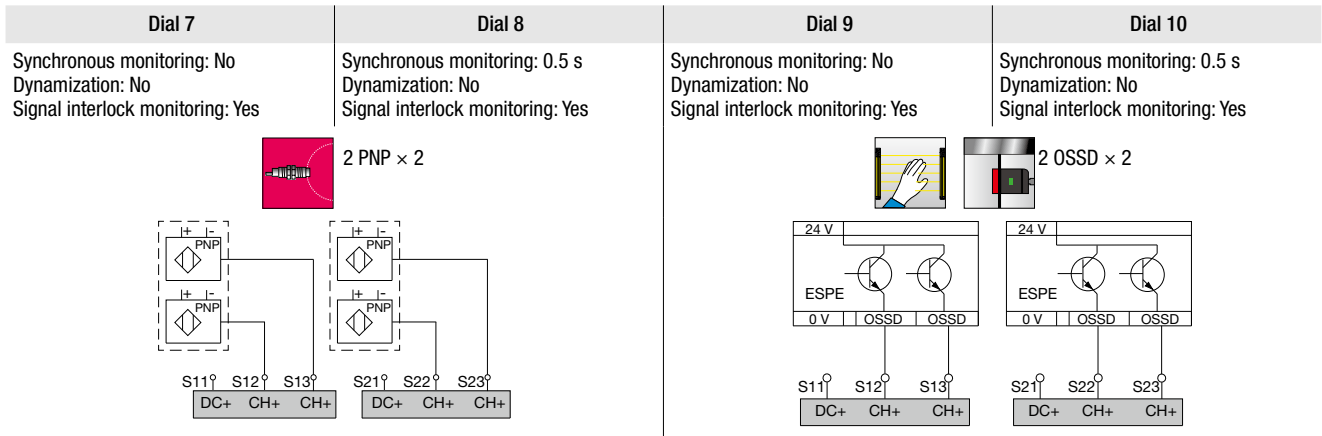

HR6S-DN Safety Relay Module

Up to 6 safety-related inputs can be connected

- Protects both the operator and the machine by immediately stopping dangerous movements when instructed to stop by the operator or when a failure in the safety circuit is detected.
- Connects up to 6 input devices in parallel. (Outputs are enabled when all inputs are enabled.)



Output expansion possible

HR6S-DN

Package Quantity: 1

Terminal	Part No.	Supply Voltage
Push-in terminal	HR6S-DN1C	24V AC/DC
Screw terminal	HR6S-DN1P	24V AC/DC

- One sealing strip (see page 28) is included with each product.



• See website for details on approvals and standards.

Overview of Application Functions

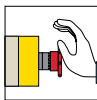

Monitoring of Emergency Stop circuits as per ISO 13850 and IEC 60204-1, stop category 0



Monitoring of guards as per ISO 14119/14120 with coded magnetic switches

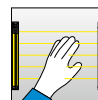

Monitoring of electro-sensitive protective equipment such as type 4 light curtains as per IEC 61496-1

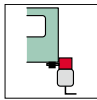

Monitoring of guards as per ISO 14119/14120 with interlock switches

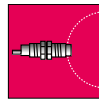

Monitoring of proximity switches

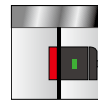

Monitoring of RFID sensors

Safety-Related Outputs

Number of relay contacts, Normally Open, instantaneous	3
Number of relay contacts, Normally Closed, instantaneous	1
Maximum short circuit current IK	1 kA
Maximum continuous current, Normally Open relay contacts	6 A
Maximum continuous current, Normally Closed relay contacts	3 A
Maximum total thermal current ΣI_{THERM}	12 A
Minimum current	10 mA
Utilization category as per UL 60947-5-1	B300 and R300 for Normally Open contacts D300 and R300 for Normally Closed contacts
Utilization category as per IEC 60947-4-1 and IEC 60947-5-1	AC-1: 250 V AC-15: 250 V DC-1: 24 V DC-13: 24 V
Maximum current, normally open relay contacts	AC-1: 5 A AC-15: 3 A DC-1: 5 A DC-13: 3 A
Maximum current, normally closed relay contacts	AC-1: 3 A AC-15: 1 A DC-1: 3 A DC-13: 1 A
External fusing	10 A, category gG, for Normally Open 4 A, category gG, for Normally Closed

Additional Non-Safety-Related Outputs

Output voltage	24V DC
Maximum current	20 mA

Synchronization Times

The synchronization times for the synchronization of safety-related inputs depend on the application function. (See page 21 to 22 Function Mode Selector and Input Device Connection Example.)

Data Functional Safety

Defined safe state	Safety-related outputs are de-energized Normally Open: open Normally Closed: closed	
Maximum Performance Level (PL), Category (as per ISO 13849-1:2015)	Normally Open: PLe, Category 4 Normally Closed: PLC, Category 1	
Maximum Safety Integrity Level (SIL) (as per IEC 61508-1:2010)	Normally Open: 3 Normally Closed: 1	
Safety Integrity Level Claim Limit (SILCL) (as per IEC 62061:2005+AMD1:2012+AMD2:2015)	Normally Open: 3 Normally Closed: 1	
Type (as per IEC 61508-2)	B	
Hardware Fault Tolerance (HFT) (as per IEC 61508 and IEC 62061)	1	
Stop Category for Emergency Stops (as per ISO 13850 and IEC 60204-1)	0	
Lifetime in years at an ambient temperature of 55 °C (131 °F)	20	
Safe Failure Fraction (SFF) (as per IEC 61508 and IEC 62061)	>99 %	
Probability of Dangerous Failure per hour (PFH _D) in 1/h (as per IEC 61508 and ISO 13849-1)	0.88×10^{-9}	
Mean Time To Dangerous Failure (MTTF _D) in years (as per ISO 13849-1)	2,500 (*1)	
Average Diagnostic Coverage (DC _{avg}) (as per ISO 13849-1)	≥99 %	
Maximum number of cycles over lifetime	DC-13	24V DC 1 A: 1200000 24V DC 3 A: 275000
	AC-1	250V AC 4 A: 90000
	AC-15	250V AC 1 A: 90000
		250V AC 5 A: 60000

*1) According to ISO 13849-1 Annex K

For other specifications (common to all models), see page 27.

HR6S-DN

Wiring Example

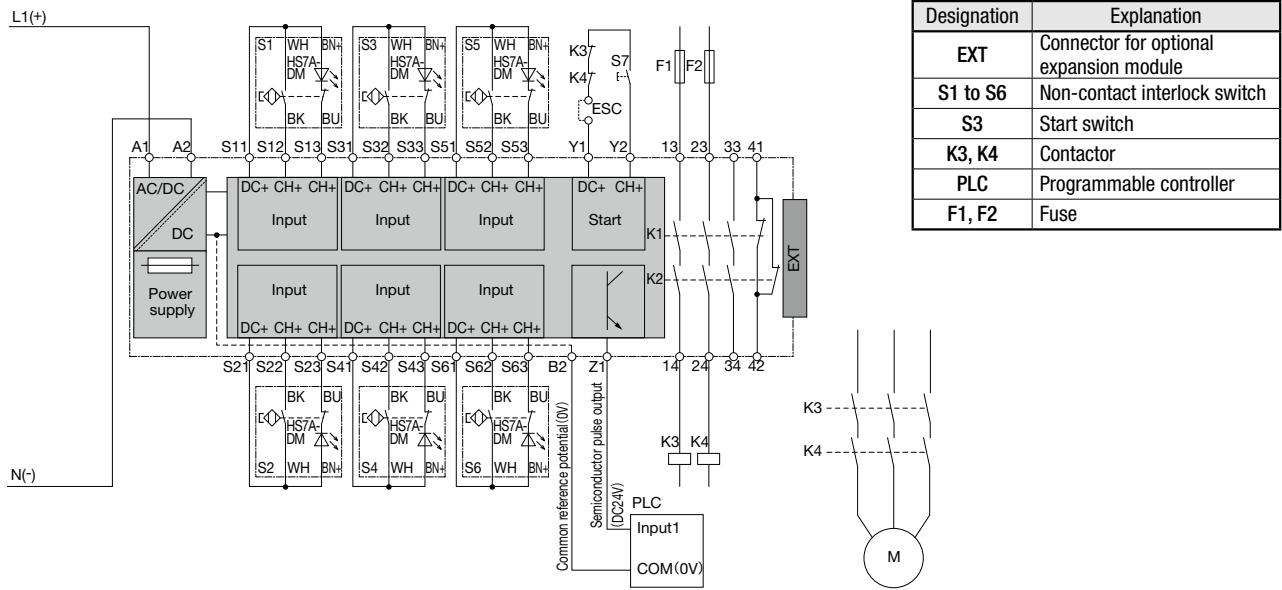

Function Mode Selector and Input Device Connection Example

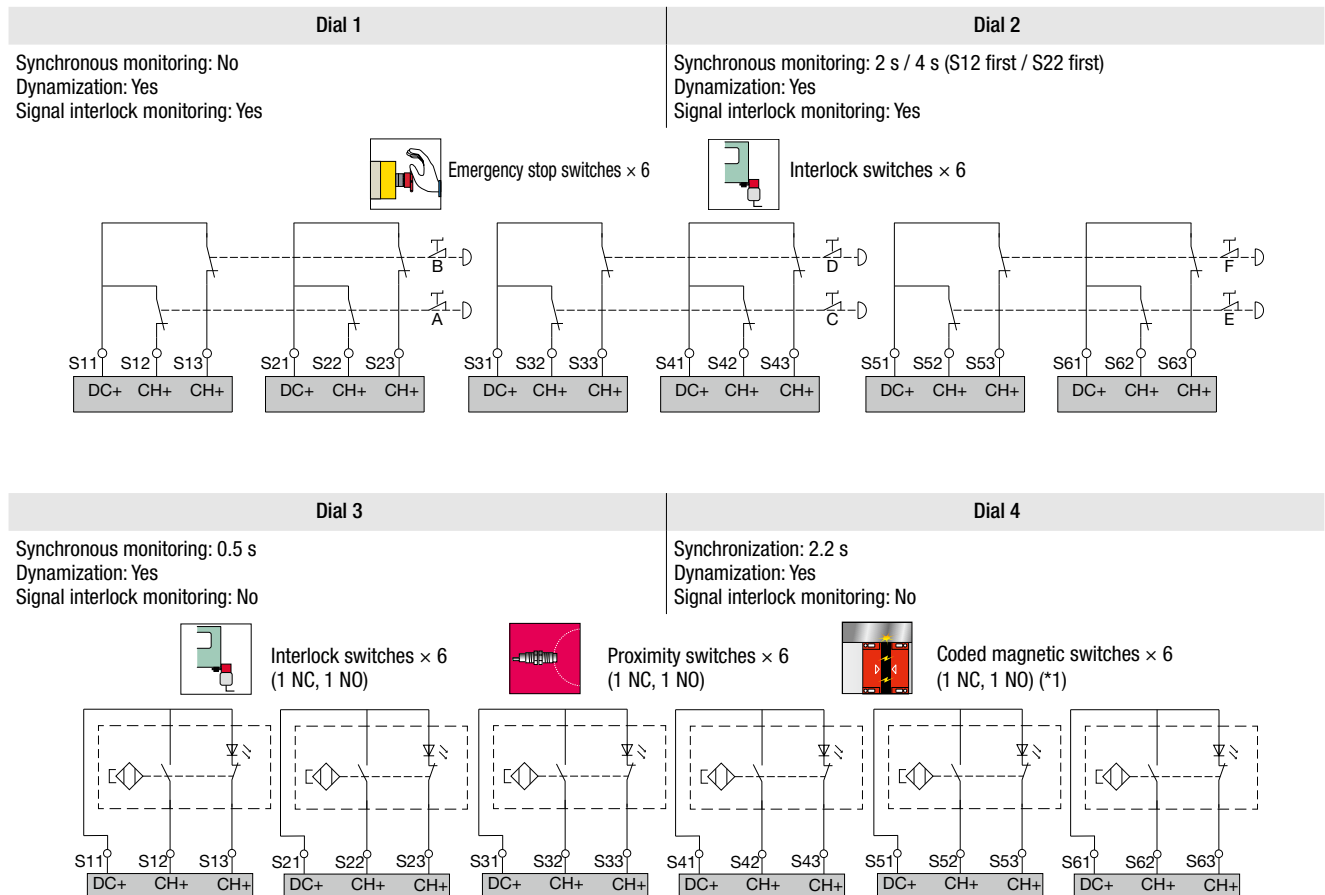

*1: Connection examples for coded magnetic switches such as HS7A (IDEC) are also included on the instruction sheet, but certifications are not available.
Note: Status of contacts in the diagram: The status of the control switch is when it is not operated. The status of the door interlock is when the door is closed.

HR6S-DN

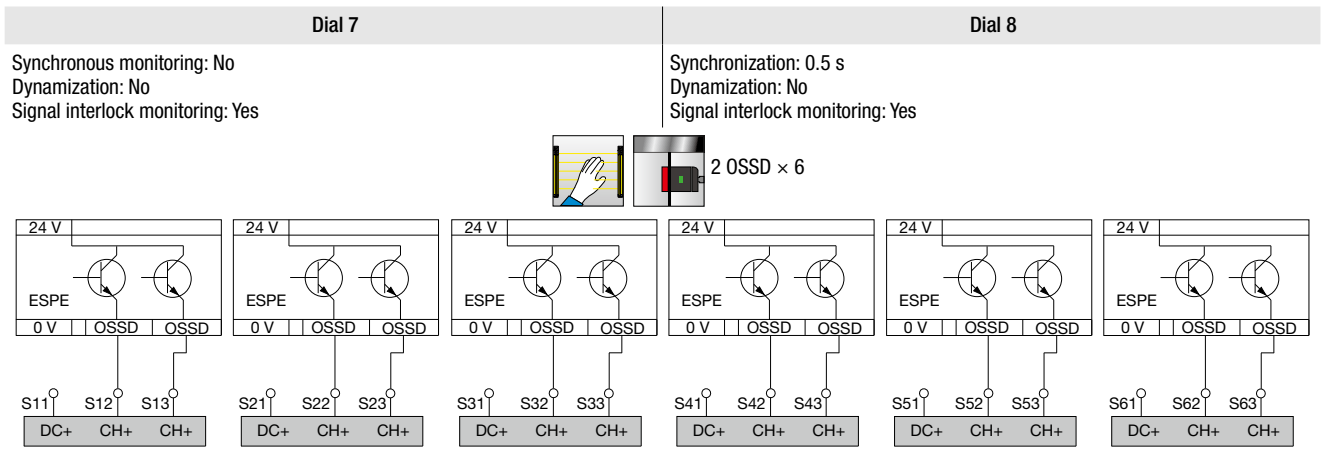
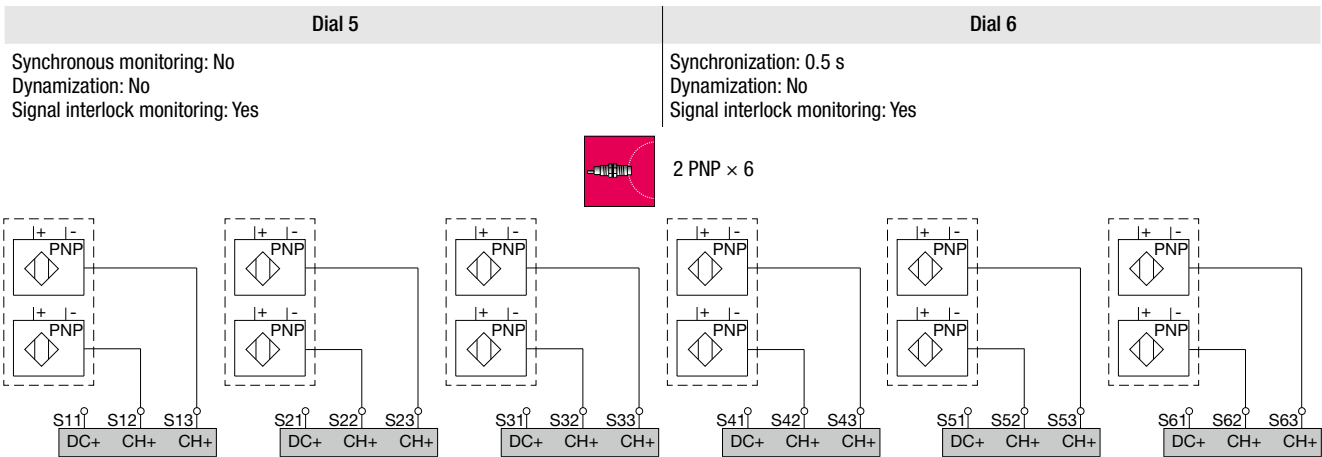

HR6S-EP Expansion Module

Module for extending safety-related outputs

- 4 NO + 2 NC outputs can be added with the HR6S-EP.
- When connected to the HR6S-AT, you can use the HR6S-AT selector to select either instantaneous output or the delayed output.



- See website for details on approvals and standards.

HR6S-EP

Package Quantity: 1

Terminal	Part No.	Supply Voltage
Push-in terminal	HR6S-EP1C	24V AC/DC
Screw terminal	HR6S-EP1P	24V AC/DC

- One sealing strip (see page 28) is included with each product.



*Not applicable to HR6S-AB

Safety-Related Outputs

Number of relay contacts, Normally Open (*1)	4
Number of relay contacts, Normally Closed (*1)	2
Maximum short circuit current IK	1 kA
Maximum continuous current, Normally Open relay contacts	6 A
Maximum continuous current, Normally Closed relay contacts	3 A
Maximum total thermal current $\sum I_{THERM}$	12 A
Minimum current	10 mA
Utilization category as per UL 60947-5-1	B300 and R300 for Normally Open contacts D300 and R300 for Normally Closed contacts
Utilization category as per IEC 60947-4-1 and IEC 60947-5-1	AC-1: 250 V AC-15: 250 V DC-1: 24 V DC-13: 24 V
Maximum current, normally open relay contacts	AC-1: 5 A AC-15: 3 A DC-1: 5 A DC-13: 3 A
Maximum current, normally closed relay contacts	AC-1: 3 A AC-15: 1 A DC-1: 3 A DC-13: 1 A
External fusing	10 A, category gG, for Normally Open 4 A, category gG, for Normally Closed

*1: Depending on the configuration of the base safety module, the relay contacts can be used as instantaneous or delayed relay contacts.

Additional Non-Safety-Related Outputs

Output voltage	24V DC
Maximum current	20 mA

Data Functional Safety

Defined safe state	Safety-related outputs are de-energized Normally Open: open Normally Closed: closed	
Maximum Performance Level (PL), Category (as per ISO 13849-1:2015)	Normally Open: PLc, Category 4 Normally Closed: PLc, Category 1	
Maximum Safety Integrity Level (SIL) (as per IEC 61508-1:2010)	Normally Open: 3 Normally Closed: 1	
Safety Integrity Level Claim Limit (SILCL) (as per IEC 62061:2005+AMD1:2012+AMD2:2015)	Normally Open: 3 Normally Closed: 1	
Type (as per IEC 61508-2)	A	
Hardware Fault Tolerance (HFT) (as per IEC 61508 and IEC 62061)	1	
Stop Category for Emergency Stops (as per ISO 13850 and IEC 60204-1)	0 or 1, depends on base safety module	
Lifetime in years at an ambient temperature of 55 °C (131 °F)	20	
Safe Failure Fraction (SFF) (as per IEC 61508 and IEC 62061)	>99 %	
Probability of Dangerous Failure per hour (PFH _D) in 1/h (as per IEC 61508 and ISO 13849-1)	0.97 × 10 ⁻⁹	
Mean Time To Dangerous Failure (MTTF _D) in years (as per ISO 13849-1)	2,300 (*2)	
Average Diagnostic Coverage (DC _{avg}) (as per ISO 13849-1)	≥99 %	
Maximum number of cycles over lifetime	DC-13	24V DC 1 A: 1200000 24V DC 3 A: 275000
	AC-1	250V AC 4 A: 90000
	AC-15	250V AC 1 A: 90000 250 VAC 5 A: 60000

*2) According to ISO 13849-1 Annex K

For other specifications (common to all models), see page 27.

HR6S-EP

Wiring Example (When connecting to HR6S-AF)

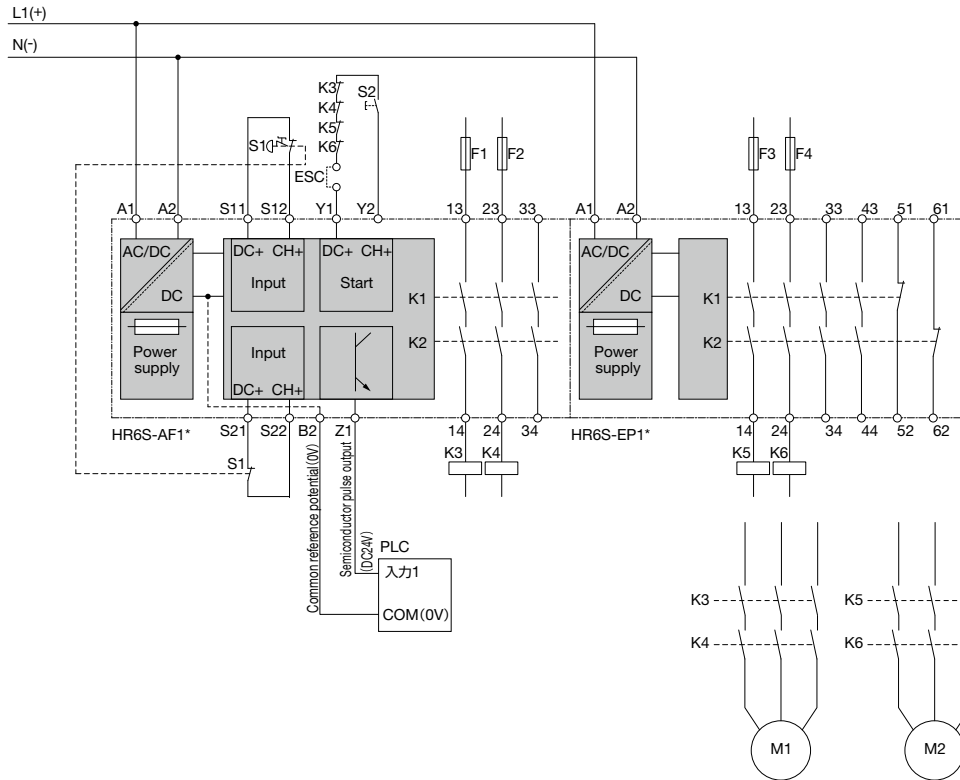

Designation	Explanation
S1	Emergency stop switch
S2	Start switch
K3 to K6	Contactors
PLC	Programmable controller
F1 to F4	Fuses

HR6S-BAC Safety Module

22.5mm-wide module with 4NO1NC output

- Protects both the operator and the machine by immediately stopping dangerous movements when instructed to stop by the operator or when a failure in the safety circuit is detected.
- Reduced wiring for safety input part.
- Slim module available with 4NO1NC safety output.



HR6S-BAC

Package Quantity: 1

Terminal	Part No.	Supply Voltage
Push-in terminal	HR6S-BAC1C	24V AC/DC
Screw terminal	HR6S-BAC1P	24V AC/DC

- One sealing strip (see page 28) is included with each product.



- See website for details on approvals and standards.

Overview of Application Functions

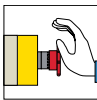

Monitoring of Emergency Stop circuits as per ISO 13850 and IEC 60204-1, stop category 0

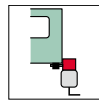

Monitoring of guards as per ISO 14119/14120 with interlock switches

Safety-Related Outputs

Number of relay contacts, Normally Open	4
Number of relay contacts, Normally Closed	1
Maximum short circuit current IK	1 kA
Maximum continuous current, Normally Open relay contacts	6 A
Maximum continuous current, Normally Closed relay contacts	3 A
Maximum total thermal current ΣI_{THERM}	16 A
Minimum current	10 mA
Utilization category as per UL 60947-5-1	B300 and R300 for Normally Open contacts D300 and R300 for Normally Closed contacts
Utilization category as per IEC 60947-4-1 and IEC 60947-5-1	AC-1: 250 V AC-15: 250 V DC-1: 24 V DC-13: 24 V
Maximum current, normally open relay contacts	AC-1: 5 A AC-15: 3 A DC-1: 5 A DC-13: 3 A
Maximum current, normally closed relay contacts	AC-1: 3 A AC-15: 1 A DC-1: 3 A DC-13: 1 A
External fusing	10 A, category gG, for Normally Open 4 A, category gG, for Normally Closed

Data Functional Safety

Defined safe state	Safety-related outputs are de-energized Normally Open: open Normally Closed: closed	
Maximum Performance Level (PL), Category (as per ISO 13849-1:2015)	Normally Open: PL _e , Category 3 Normally Closed: PL _c , Category 1	
Maximum Safety Integrity Level (SIL) (as per IEC 61508-1:2010)	Normally Open: 3 Normally Closed: 1	
Safety Integrity Level Claim Limit (SILCL) (as per IEC 62061:2005+AMD1:2012+AMD2:2015)	Normally Open: 3 Normally Closed: 1	
Type (as per IEC 61508-2)	B	
Hardware Fault Tolerance (HFT) (as per IEC 61508 and IEC 62061)	1	
Stop Category for Emergency Stops (as per ISO 13850 and IEC 60204-1)	0	
Lifetime in years at an ambient temperature of 55 °C (131 °F)	20	
Safe Failure Fraction (SFF) (as per IEC 61508 and IEC 62061)	>99 %	
Probability of Dangerous Failure per hour (PFH _d) in 1/h (as per IEC 61508 and ISO 13849-1)	0.95 × 10 ⁻⁹	
Mean Time To Dangerous Failure (MTTF _D) in years (as per ISO 13849-1)	2,300 (*1)	
Average Diagnostic Coverage (DC _{avg}) (as per ISO 13849-1)	≥99 %	
Maximum number of cycles over lifetime	DC-13	24V DC 1 A: 1200000
		24V DC 3 A: 275000
	AC-1	250V AC 4 A: 90000
		250V AC 1 A: 90000
AC-15	250V AC 5 A: 70000	
	250V AC 1 A: 70000	

*1) According to ISO 13849-1 Annex K

For other specifications (common to all models), see page 27.

HR6S-BAC

Wiring Example

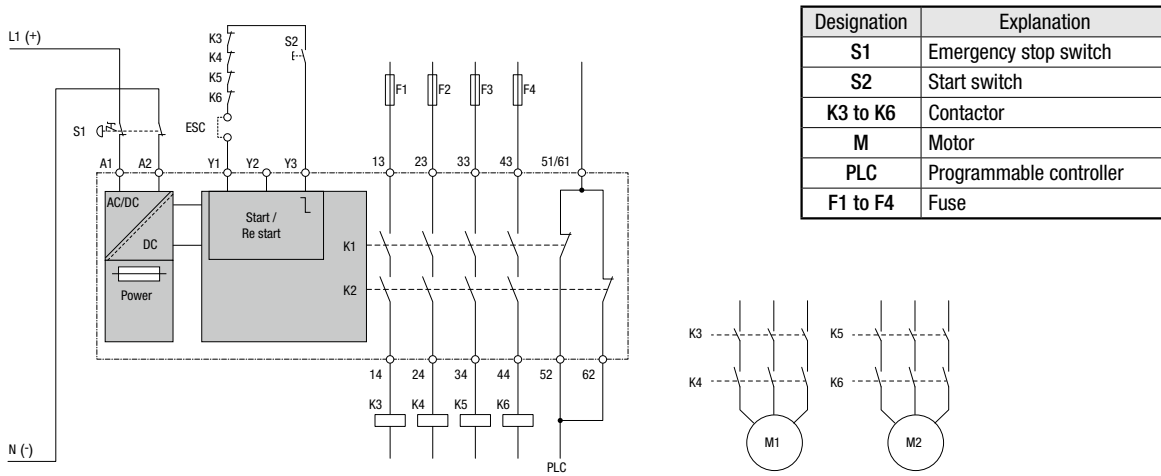

Input Device Connection Example

Synchronous monitoring: No
 Dynamization: No
 Signal interlock monitoring: Yes

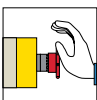

Monitoring of Emergency Stop Switch

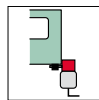

Interlock Switch

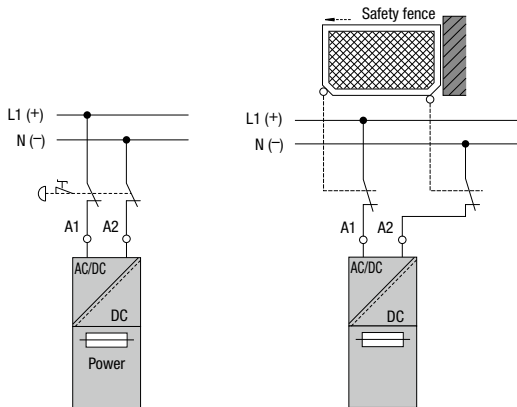

Note: Status of contacts in the diagram: The status of the control switch is when it is not operated. The status of the door interlock is when the door is closed.

Common Specifications

Applicable Standards

Applicable Standards	IEC 61508:2010 IEC 62061:2015 ISO 13849-1:2015 IEC 60947-5-1:2016 IEC 60947-1:2007 UL60947-5-1 CAN/CSA C22.2 No. 60947-5-1 GB/T14048.5-2017
----------------------	--

Environmental Characteristics for Operation

Maximum installation altitude above mean sea level	2,000 m
Installation required in control cabinet/ enclosure with degree of protection	IP54

The device complies with class 3K5 and special class 3Z11 as per IEC 60721-3-3 (climatic conditions):

Ambient temperature	-25 to +55 °C (no freezing)
HR6S-DN	24 VAC: -25 to +50 °C (no freezing) 24V DC: -25 to +55 °C (no freezing)
Temperature variation rate	0.5 °C/min
Ambient humidity	5 to 95 % relative humidity (no condensation)

The device complies with class 3M4 as per IEC 60721-3-3 (mechanical conditions):

Vibration, sinusoidal, displacement amplitude 2 to 9 Hz	3 mm
Vibration, sinusoidal, acceleration amplitude 9 to 200 Hz	10 m/s ²
Shock, shock pulse shape: half-sine, peak acceleration	100 m/s ²

The device complies with the following vibration and shock values as per IEC 60947-1:

Vibration, sinusoidal, displacement amplitude 2 to 13 Hz	1 mm
Vibration, sinusoidal, acceleration amplitude 13.2 to 100 Hz	7 m/s ²
Shock, shock pulse shape: half-sine, peak acceleration	150 m/s ²

Environmental Characteristics for Storage

The device complies with class 1K5 as per IEC 60721-3-1 (climatic conditions):

Ambient temperature	-40 to 70 °C, no freezing
Ambient humidity	10 to 100 % relative humidity, no condensation

The device complies with class 2M2 as per IEC 60721-3-2 (mechanical conditions):

Vibration, sinusoidal, displacement amplitude 2 to 9 Hz	1.5 mm
Vibration, sinusoidal, acceleration amplitude 9 to 200 Hz	5 m/s ²
Shock, shock response spectrum type L, peak acceleration	40 m/s ²

Electrical Data

Supply voltage	24V AC -15 to 10 % 50 to 60 Hz 24V DC -20 to 20 %	
Nominal input power	HR6S-AB / EP / BAC	3.5 VA (24V AC), 1.5 W (24V DC)
	HR6S-AF / AK	5 VA (24V AC), 2 W (24V DC)
	HR6S-AT	6.5 VA (24V AC), 3 W (24V DC)
	HR6S-DN	10.5 VA (24V AC), 4.5W (24V DC)
Overvoltage category	II	
Pollution degree	2	
Insulation voltage	300 V	
Impulse withstand voltage	4 kV	
Conducted and radiated emissions as per IEC CISPR 11	Group 1 / Class B	
Usage in environment as per IEC/UL 60947-1	Environment B	

Wire Cross Sections, Stripping Lengths, and Tightening Torques

Stripping length for Push-in terminals	12 mm	
Stripping length for screw terminals	7 to 8 mm	
Wire cross section	Single wire without wire ferrule (*1)	0.2 to 2.5 mm ² (24 to 12 AWG)
	Single wire with wire ferrule (*2)	0.25 to 2.5 mm ² (24 to 12 AWG)
	Two wires without wire ferrule (*1)	0.2 to 1.5 mm ² (24 to 16 AWG)
	Two wires with uninsulated wire ferrule	0.25 to 1 mm ² (24 to 18 AWG)
	Two wires with insulated wire ferrule (*2)	0.5 to 1.5 mm ² (20 to 16 AWG)
Tightening torque for screw terminals	0.5 to 0.6 N m	

*1: Stranded or solid

*2: See page 28 "Recommended ferrules" for ferrules.



Timing Data

Maximum response time to request at safety-related input (except HR6S-BAC)	20 ms
Maximum response time after power outage AC	140 ms (HR6S-EP) 150 ms (HR6S-BAC) 200 ms
Maximum response time after power outage DC	80 ms (HR6S-BAC) 100 ms (HR6S-EP) 120 ms 140 ms (HR6S-DN / AT)
Recovery time after request at safety-related input (except HR6S-BAC)	200 ms
Switch on delay after power on and automatic start	1500 ms (HR6S-BAC) 2500 ms 3000 ms (HR6S-DN)
Delay after activation of safety-related input or valid start condition	100 ms
Delay after power on and monitored start	1500 ms (HR6S-BAC) 2500 ms 3000 ms (HR6S-DN)
Minimum duration of start pulse for monitored start	80 ms
Debounce time, standard	2.5 ms
Debounce time, with OSSD	4 ms
Signal interlock monitoring time	200 ms

Dynamization of Safety-Related Inputs and Start Input (except HR6S-EP)

Test pulse duration (safety-related input must be activated for longer than duration of test pulse)	2 ms
Test pulse interval	500 ms 1000 ms (HR6S-DN)
Maximum delay of test pulse	40 ms
Test pulse phase shift (except HR6S-BAC)	At least 70 ms

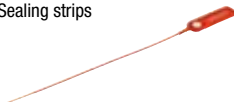
Accessories

Name / Appearance	Part No.	Package Quantity	Remarks
Coding bits 	HR9Z-EC	30	Red plastic parts mounts on the four grooves on the terminal block, and yellow resin parts mounts in the grooves in the same position on the main unit. The terminal block cannot be inserted if the plastic parts collide with each other, so by changing the mounting position for each terminal, insertion into the wrong position is prevented.
Sealing strips 	HR9Z-ES	10	1 sealing strip is included. Used to lock the front transparent cover to prevent dial setting changes. Printed with a 10 digit serial number for management purposes 

DIN Rails





When ordering, specify the Ordering No.

Name / Appearance	Part No.	Ordering No.	Package Quantity	Remarks
DIN 35 mm rails	BAA1000	BAA1000PN10	10	Aluminum Length: 1000 mm Weight (approx.): 200 g
End clips	BNL6	BNL6PN10	10	Metal (zinc-plated steel) Weight (approx.): 15 g Compatible rails: BAA1000

Recommended ferrules

Item	Wire cross-section (mm ²)		Part No.	Color	Package Quantity			
	AWG	mm ²						
Ferrule with insulated cover Standard pack 	Push-in terminal	For single wire	20	0.5	S3TL-H05-18WA	● Orange	500	
			18	0.75	S3TL-H075-18WW	○ White		
		17	1.0	S3TL-H10-18WY	● Yellow			
		14	2.5	S3TL-H25-19DS	● Blue			
	Screw terminal	For two wire		20	0.5	S3TL-J05-18WA	● Orange	500
				18	0.75	S3TL-J075-19WWS	○ White	
				17	1	S3TL-J10-19WY	● Yellow	
				16	1.5	S3TL-J15-20WR	● Red	
		For single wire		24	0.25	S3TL-H025-12WJ	● Light blue	500
				22	0.34	S3TL-H034-12WT	● Turquoise	
				20	0.5	S3TL-H05-14WA	● Orange	
				18	0.75	S3TL-H075-14WW	○ White	
For two wire		17	1.0	S3TL-H10-14WY	● Yellow	500		
		16	1.5	S3TL-H15-14WR	● Red			
		14	2.5	S3TL-H25-15DS	● Blue			
		20	0.5	S3TL-J05-14WA	● Orange			
		18	0.75	S3TL-J075-14WW	○ White	500		
		17	1	S3TL-J10-15WY	● Yellow			
		16	1.5	S3TL-J15-16WR	● Red			

Tools

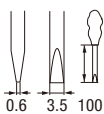
Name / Shape	Part No.	Package Quantity	Remarks
Crimping tool (for ferrules) 	S3TL-CR04T	1	Crimping shape: Trapezoidal 
Crimping tool (for ferrules) 	S3TL-CR06D	1	Crimping shape: Trapezoidal Indent 
Insulated screwdriver 	S3TL-D06-35-100	1	Blade size (Dimensions in mm.) 

Dimensions

(Dimensions in mm.)

HR6S-AF, HR6S-AK, HR6S-S

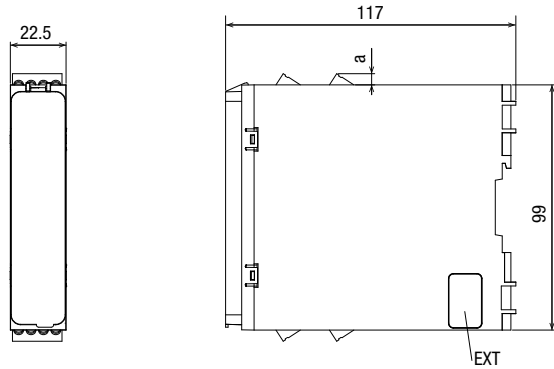

Weight: 200 g

HR6S-AT

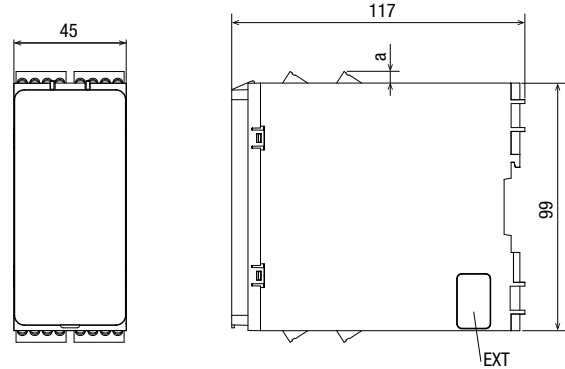

Weight: 350 g

HR6S-AB

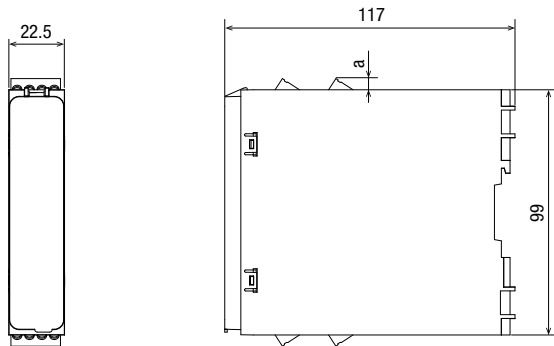

Weight: 200 g

HR6S-DN

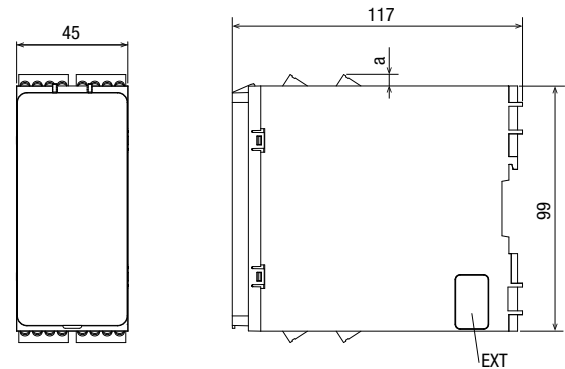

Weight: 350 g

HR6S-EP

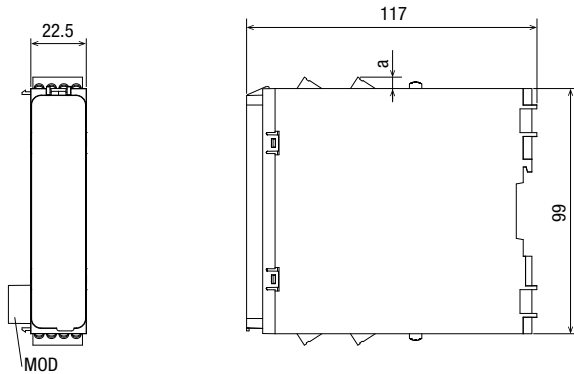

Weight: 200 g

HR6S-BAC

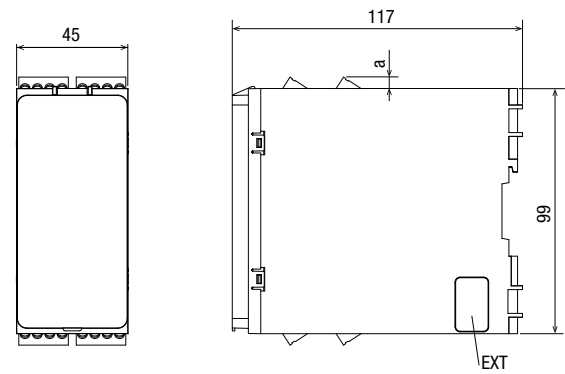

Weight: 200 g

- The maximum dimensions when the front transparent cover is opened are 154 mm in height and 202 mm in depth.

Designation	Explanation
a	Push-in terminal: 10 mm Screw terminal: 5 mm
EXT	Connector for output expansion module (side)
MOD	Connector for base safety module

LED Display (Example for HR6S-AT)

LED	State	Explanation
POWER	○	Power supply on
	●	No power supply
Snn	○	Safety-related input activated
	●	Safety-related input deactivated
START	○	Valid start condition
	●	No valid start condition
	○ ●	Waiting for valid start condition
STATEn (*3)	○	Normally open safety-related outputs activated
	●	Normally open safety-related outputs deactivated
ERROR Snn (*1) Snn (*1)	○ ● ○ ● ○ ●	Synchronization time alert Other LEDs retain normal behavior
ERROR Snn (*2) Snn (*2)	○ ● ○ ● ○ ●	Interlock alert Other LEDs retain normal behavior
ERROR LEDs (*4)	○ ○ ●	General error detected Module in defined safe state
ERROR LEDs (*4)	○ ○	Configuration error detected
ERROR POWER	○ ○ ●	Power supply error detected

LED	State	Explanation
ERROR Snn (*2) Snn (*2)	○ ○ ● ○ ●	Cross circuit detected at safety-related input
ERROR START	○ ○ ●	Cross circuit detected at Start input
ERROR STATEn (*3)	○ ○ ●	Error detected at safety-related output
ERROR START STATEn (*3)	○ ○ ● ○ ●	Error detected at safety-related output of expansion module
LEDs	○	All LEDs light up during power-up for diagnostics purposes.

- : LED solid on
- : LED off
- ● : LED flashing

*1: Snn: n = number off LED of affected input, LEDs flashing alternately

*2: Snn: n = number off LED of affected input, LEDs flashing synchronously

*3: STATEn: n = 1 = Instantaneous
n = 2 = Delay

*4: LEDs: All LEDs except POWER

* For details, refer to the instruction sheet.

Start Function Selector (Common to All Types)

Selector Position	Start Function	Startup Test (*3)	Dynamization (*8)
1	Manual/automatic start (*5)	No	Yes
2	Manual/automatic start (*5)	Yes	Yes
3	Monitored start (*6)	No	Yes
4	Monitored start (*2)	Yes	Yes
5	Manual/automatic start (*1)	No	No
6	Manual/automatic start (*1)	Yes	No
7	Monitored start (*2)	No	No
8	Monitored start (*2)	Yes	No

- *5) Automatic start when start terminals Y1 and Y2 are short-circuited.
- *6) When the switch is used to start, start is triggered at the falling edge of the start signal. The safety-related input must be activated for a period of at least 80 ms.
- *7) When the startup test is set to "Yes", the safety-related input must be disabled and then re-enabled before the safety-related output can be turned on. Normally, it is used to monitor guards. Even if the automatic start mode is selected and the guard is closed, after power is turned on, the guard must first be opened and closed.
- *8) Start input Y2 watches the pulse superimposed on the output from Y1 to check that there is no short-circuit between other input wires and power supply wires, and then starts. When 24V signals are input to Y2 from PLCs, select "Dynamization - No".

Status Monitor by Diagnosis

Explanation of Status Output

The HR6S diagnoses and monitors connected devices, and can output the results to the Tr output (not safety-related).

The status monitor outputs a pulse signal instead of I/O.

The length of the diagnostic bit sequence output from status output Z1 is 2 s. The configuration is a 10-bit signal where each bit is 200 ms. The first 4 bits (0010) are the start codes that represent the start of the bit sequence. The next 6 bits are a diagnostics code that indicates the status of the HR6S.

The cycle time (scan time) of the task that executes the program must be 50 ms or less for the bit sequence to be detected correctly. A ladder program for decoding by PLC is provided. (Contact IDEC regarding PLC ladder programs for IDEC FC6A PLC or other manufacturer's PLCs.)

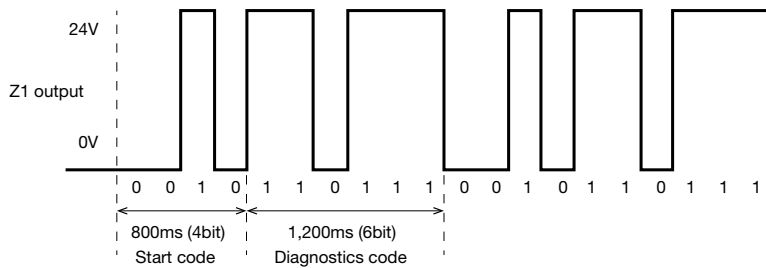

Note 1: If the status of the HR6S changes during the output of the bit sequence, it will be sent in the next sequence. Therefore, the maximum delay in status output for a change of status is 4 s.

However, if the running bit sequence does not last until the next sequence starts (if status changes occur within 2 s), it will not be sent in the next sequence.

Note 2: Turning off the power connected to the HR6S safety module can cause the ladder program to detect incorrect status information.

Diagnostics Codes

Bit sequence	Description	Correctives	Type (*1)
0010101101	Supply voltage out of tolerance.	Verify correct wiring. Use a suitable power supply.	E
0010000011	General error detected.	Verify correct wiring. Perform a power cycle. If the error persists, replace the device.	E
0010000110	Configuration error detected with the expansion module. The position of at least one of the selectors has been modified during operation.	Verify correct wiring. Turn on the power to this product and the connected expansion module again. If the error persists, replace the expansion module.	E
0010000111	Synchronization alert. Both synchronized safety-related inputs have been activated, but not within the synchronization time.	Verify that the position of the selectors is appropriate for the application to be implemented. Perform a power cycle. If the error persists, replace the device.	E
0010001100	Cross circuit detected at input terminal S12.	Verify correct wiring. Verify that the sensor/device providing the input signal is suitable for cross circuit detection by means of dynamization. If it is not, use an application function without dynamization or a sensor/device suitable for dynamization. Verify correct operation of sensor/device providing the input signal. Perform a power cycle.	E
0010001111	Cross circuit detected at input terminal S22.	Verify correct wiring. Verify that the sensor/device providing the input signal is suitable for cross circuit detection by means of dynamization. If it is not, use an application function without dynamization or a sensor/device suitable for dynamization. Verify correct operation of sensor/device providing the input signal. Perform a power cycle.	E
0010011000	Cross circuit detected at input terminal S32.	Verify correct wiring. Verify that the sensor/device providing the input signal is suitable for cross circuit detection by means of dynamization. If it is not, use an application function without dynamization or a sensor/device suitable for dynamization. Verify correct operation of sensor/device providing the input signal. Perform a power cycle.	E
0010110000	A cross circuit has been detected at the start input.	Verify correct wiring. Verify that the sensor/device providing the input signal is suitable for cross circuit detection by means of dynamization. If it is not, use an application function without dynamization or a sensor/device suitable for dynamization. Verify correct operation of sensor/device providing the input signal. Perform a power cycle.	E
0010100011	A cross circuit has been detected at the input used for the delay cancel function.	Verify correct wiring. Verify that the sensor/device providing the input signal is suitable for cross circuit detection by means of dynamization. If it is not, use an application function without dynamization or a sensor/device suitable for dynamization. Verify correct operation of sensor/device providing the input signal. Perform a power cycle.	E
0010110011	Synchronization alert. One of the synchronized safety-related inputs is still deactivated, but the synchronization time has already elapsed.	Please restore the input state and try again. Verify correct operation of sensor/device providing the input signal.	A
0010100111	Synchronization alert. Both synchronized safety-related inputs have been activated, but not within the synchronization time.	Please restore the input state and try again. Verify correct operation of sensor/device providing the input signal.	A

*1) Message type: E = Error detected, A = Alert

Bit sequence	Description	Type (*2)
0010110110	Instantaneous safety-related outputs are deactivated, and delay safety-related outputs remain activated.	S
0010110111	Both safety-related inputs and safety-related outputs are deactivated.	S
0010110101	Waiting for the state of input S12 to change. If this setting is by antivalent input, waits for the state of inputs S12 and S13 to change.	S
0010111100	Waiting for the state of input S22 to change. If this setting is by antivalent input, waits for the state of inputs S22 and S23 to change.	S
0010111111	Waiting for the state of input S32 to change. If this setting is by antivalent input, waits for the state of inputs S32 and S33 to change.	S
0010101011	Waiting for startup test.	S
0010101010	Waiting for rising edge for automatic/manual start or monitored start.	S
0010101110	Valid start condition. Waiting for the falling edge for a monitored start.	S
0010101111	The operating status of this product is "Operating: Output is on", and safety-related outputs are activated.	S

*2) Message type: S = Status information

Safety Systems

- Perform operations, adjustments, and maintenance according to the standards applicable to the electric machine.
- For input devices and output devices for safety control that are connected to this product, use products that comply with the standards that are required to meet the requirements for ISO13849-1 safety systems.

⚠ Safety Precautions

- Do not disassemble, repair, or modify the product. This may cause impairment of the safe operability of the safety relay module.
- This product is not intended for use in applications that require a high degree of safety and reliability, such as nuclear power, railways, aviation, and passenger equipment. Do not use this product for such applications.
- Turn off the power to the product before starting installation, removing, wiring, maintenance, or inspection of the safety relay module. Failure to turn power off may cause electric shocks or fire hazard.
- Be sure to read the instructions attached to the product or website and use under the appropriate environment. Insufficient installation may lead to damage or failure.
- Make sure to take measures to prevent electric shock due to insulation damage between outputs.
- Use within the specified voltage. Do not use a power supply that produce high ripple voltage or abnormal voltage.
- Use a power supply that meets following required specifications;
 - Complies with SELV or PELV circuit specified by IEC 60364-4-41.
 - Has the functionality of the control voltage and current of class 2 circuit, as defined in UL508.
- Check the safety function of the product periodically, turn OFF the signal to the safety input (e.g. at least once a year) and make sure the safety outputs turn OFF.
- The product is designed for installation within an enclosure. Do not install the product outside an enclosure. Install the product in an enclosure rated IP54 or higher.
- Install the product in environments described in this instruction sheet. If the safety relay module is used in places where the product is subjected to high temperature, high humidity, condensation, corrosive gases, excessive vibrations, and excessive shocks then electric shocks, fire hazard, or malfunction may result.
- Environment for using the product is "Pollution degree 2". Use the safety relay module under pollution degree 2 environment.
- When disposing the product, follow the laws and regulations of the country where it is disposed.

- The wiring diagrams shown in this catalog are only examples. To ensure that your safety system meets a suitable performance level, please conduct a risk assessment and consult with a third-party certification body.

• Removal procedure

- (1) Use a screwdriver to release the clip on the DIN rail.
- (2) Pull the bottom of the product away from the DIN rail, and then lift the product upward to remove it from the DIN rail.

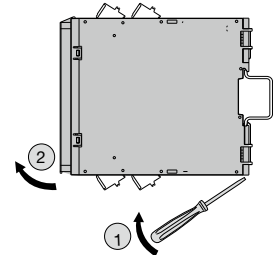

Mounting with screws

• Installation procedure

- (1) Push the included fastener into the groove on the product.
- (2) Make holes in the surface of the panel where the product will be mounted.
- (3) Use the specified screws and ISO 7093 compliant M4 washers to mount the product on the installation surface.

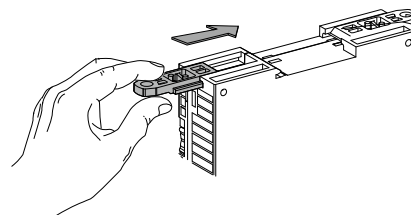
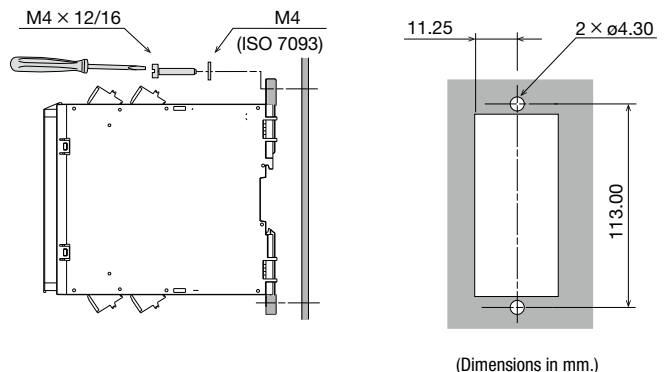

Opening the Transparent Cover

Press in the hook (indicated by the arrow) with fingernail, and then lift the transparent cover.

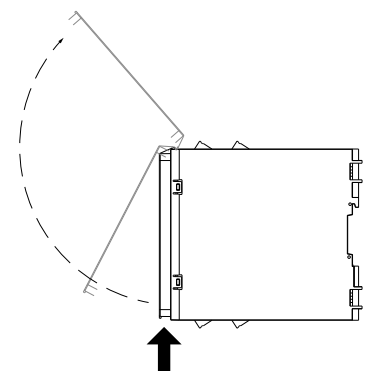

Installation/Removal

DIN Rails (BAA1000 (Sold separately: See page 28.))

HR6S can be mounted on the below DIN rails that comply with IEC 60715.
35 x 15 mm, 35 x 7.5 mm

• Installation procedure

- (1) Tilt the product slightly and hook on to the DIN rail.
- (2) Push the bottom of the product towards the DIN rail.
- (3) Push until the product is securely attached to the clip on the DIN rail.

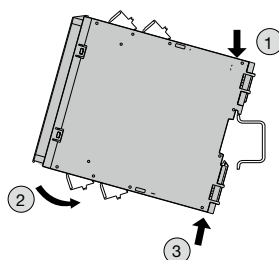

⚠ Safety Precautions

Wiring Procedure

Insert

- (1) Insert the solid wire or stranded wire with ferrule into the terminal entrance.
- (2) After wiring, tug lightly to make sure that the wire is properly connected.
*When inserting stranded wires directly, make sure that the pusher is pressed down and there are no loose wires.



Remove

- (1) Press the pusher using a flat screwdriver.
- (2) Remove the wire by pressing the pusher.



- For details on wire cross sections, stripping lengths, and tightening torques, see page 27.

Category 2 Safety Relay Module HR5S



**Safety measures for low risk machines
Category 2 Safety Relay Module**

Introducing a safety system for low risk machines

Designing a category 2 system has been difficult and only a redundant system (category 3) could be used to protect machines against relatively minor hazards.

However, with the HR5S safety relay module, designing a category 2 system is easy and enables cost reduction and saves maintenance time.

See IDEC website for more details.

Performance of Category 2 system

System that eliminates short-circuit fault detection when wiring from an input device

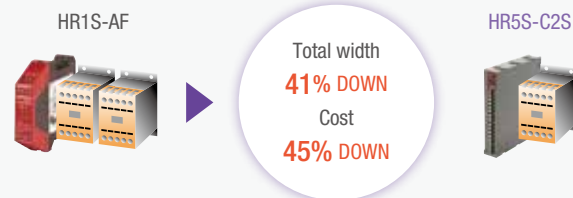

System with off-delay control system

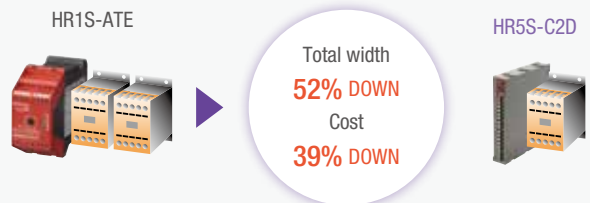

Ordering Terms and Conditions

Thank you for using IDEC Products.

By purchasing products listed in our catalogs, datasheets, and the like (hereinafter referred to as "Catalogs") you agree to be bound by these terms and conditions. Please read and agree to the terms and conditions before placing your order.

1. Notes on contents of Catalogs

- (1) Rated values, performance values, and specification values of IDEC products listed in this Catalog are values acquired under respective conditions in independent testing, and do not guarantee values gained in combined conditions.
Also, durability varies depending on the usage environment and usage conditions.
- (2) Reference data and reference values listed in Catalogs are for reference purposes only, and do not guarantee that the product will always operate appropriately in that range.
- (3) The specifications / appearance and accessories of IDEC products listed in Catalogs are subject to change or termination of sales without notice, for improvement or other reasons.
- (4) The content of Catalogs is subject to change without notice.

2. Note on applications

- (1) If using IDEC products in combination with other products, confirm the applicable laws / regulations and standards.
Also, confirm that IDEC products are compatible with your systems, machines, devices, and the like by using under the actual conditions. IDEC shall bear no liability whatsoever regarding the compatibility with IDEC products.
- (2) The usage examples and application examples listed in Catalogs are for reference purposes only. Therefore, when introducing a product, confirm the performance and safety of the instruments, devices, and the like before use. Furthermore, regarding these examples, IDEC does not grant license to use IDEC products to you, and IDEC offers no warranties regarding the ownership of intellectual property rights or non-infringement upon the intellectual property rights of third parties.
- (3) When using IDEC products, be cautious when implementing the following.
 - i. Use of IDEC products with sufficient allowance for rating and performance
 - ii. Safety design, including redundant design and malfunction prevention design that prevents other danger and damage even in the event that an IDEC product fails
 - iii. Wiring and installation that ensures the IDEC product used in your system, machine, device, or the like can perform and function according to its specifications
- (4) Continuing to use an IDEC product even after the performance has deteriorated can result in abnormal heat, smoke, fires, and the like due to insulation deterioration or the like. Perform periodic maintenance for IDEC products and the systems, machines, devices, and the like in which they are used.
- (5) IDEC products are developed and manufactured as general-purpose products for general industrial products. They are not intended for use in the following applications, and in the event that you use an IDEC product for these applications, unless otherwise agreed upon between you and IDEC, IDEC shall provide no guarantees whatsoever regarding IDEC products.
 - i. Use in applications that require a high degree of safety, including nuclear power control equipment, transportation equipment (railroads / airplanes / ships / vehicles / vehicle instruments, etc.), equipment for use in outer space, elevating equipment, medical instruments, safety devices, or any other equipment, instruments, or the like that could endanger life or human health
 - ii. Use in applications that require a high degree of reliability, such as provision systems for gas / waterworks / electricity, etc., systems that operate continuously for 24 hours, and settlement systems
 - iii. Use in applications where the product may be handled or used deviating from the specifications or conditions / environment listed in the Catalogs, such as equipment used outdoors or applications in environments subject to chemical pollution or electromagnetic interference
If you would like to use IDEC products in the above applications, be sure to consult with an IDEC sales representative.

3. Inspections

We ask that you implement inspections for IDEC products you purchase without delay, as well as thoroughly keep in mind management/maintenance regarding handling of the product before and during the inspection.

4. Warranty

- (1) Warranty period
The warranty period for IDEC products shall be one (1) year after purchase or delivery to the specified location. However, this shall not apply in cases where there is a different specification in the Catalogs or there is another agreement in place between you and IDEC.
- (2) Warranty scope
Should a failure occur in an IDEC product during the above warranty period for reasons attributable to IDEC, then IDEC shall replace or repair that product, free of charge, at the purchase location / delivery location of the product, or an IDEC service base. However, failures caused by the following reasons shall be deemed outside the scope of this warranty.
 - i. The product was handled or used deviating from the conditions / environment listed in the Catalogs
 - ii. The failure was caused by reasons other than an IDEC product
 - iii. Modification or repair was performed by a party other than IDEC
 - iv. The failure was caused by a software program of a party other than IDEC
 - v. The product was used outside of its original purpose
 - vi. Replacement of maintenance parts, installation of accessories, or the like was not performed properly in accordance with the user's manual and Catalogs
 - vii. The failure could not have been predicted with the scientific and technical standards at the time when the product was shipped from IDEC.
 - viii. The failure was due to other causes not attributable to IDEC (including cases of force majeure such as natural disasters and other disasters)
 Furthermore, the warranty described here refers to a warranty on the IDEC product as a unit, and damages induced by the failure of an IDEC product are excluded from this warranty.

5. Limitation of liability

The warranty listed in this Agreement is the full and complete warranty for IDEC products, and IDEC shall bear no liability whatsoever regarding special damages, indirect damages, incidental damages, or passive damages that occurred due to an IDEC product.

6. Service scope

The prices of IDEC products do not include the cost of services, such as dispatching technicians. Therefore, separate fees are required in the following cases.

- (1) Instructions for installation / adjustment and accompaniment at test operation (including creating application software and testing operation, etc.)
- (2) Maintenance inspections, adjustments, and repairs
- (3) Technical instructions and technical training
- (4) Product tests or inspections specified by you

The above content assumes transactions and usage within your region. Please consult with an IDEC sales representative regarding transactions and usage outside of your region. Also, IDEC provides no guarantees whatsoever regarding IDEC products sold outside your region.

IDEC CORPORATION

Head Office 6-64, Nishi-Miyahara-2-Chome, Yodogawa-ku, Osaka 532-0004, Japan

 www.idec.com

USA	IDEC Corporation	Singapore	IDEC Izumi Asia Pte. Ltd.	China	IDEC (Shanghai) Corporation	Japan	IDEC Corporation
EMEA	APEM SAS	Thailand	IDEC Asia (Thailand) Co., Ltd.		IDEC Izumi (H.K.) Co., Ltd.		
		India	IDEC Controls India Private Ltd.	Taiwan	IDEC Taiwan Corporation		

Specifications and other descriptions in this brochure are subject to change without notice.
Information in this brochure is current as of February, 2023.
2023 IDEC Corporation, All Rights Reserved.

EP1796-0

